

RADIO CRAFT

AND POPULAR ELECTRONICS

RADIO PILOT
MINE DESTROYERS
SEE PAGE 138



ALEX SCHOMBURG

DECEMBER

1943

25¢

CANADA 30¢

RADIO-ELECTRONICS IN ALL ITS PHASES

Over HERE—a Knock at the Door means a Neighbor Calling

In Axis countries, that knock might be the Gestapo—and death, if you had been listening to American news from Algiers or British news from London or the underground radio.

In America, no one cares if you listen to enemy stations—their propaganda is often good for a hearty laugh. But for unbiased war news, we tune to our own stations. We know that we will hear every important news break that won't help the enemy.

Radio has done much to make Americans the best informed people on earth. Through the ingenuity and skill of American radio manufacturers, fine-quality sets have been brought within the reach of everyone.

While today American radio makers are devoted solely to the cause of Allied Victory, important new techniques developed under stress of war will bring you finer radios and other electronic products when the war is won.

Your purchase of War Bonds will help supply American fighting men with the world's finest equipment.

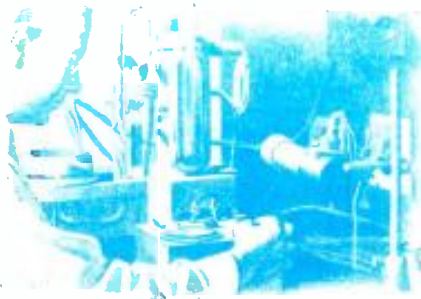

Pioneers in the field of Radio-Electronic Research, RCA Laboratories are proud of the privilege of serving America's great radio industry in its united war against the Axis. When the day of Victory comes, RCA, through basic research, will continue to work hand in hand with American manufacturers for better and more useful radio equipment in our peacetime world.



RCA Laboratories



A SERVICE OF RADIO CORPORATION OF AMERICA

FREE Lesson in Radio

Gives You a Real Start Toward Understanding These Subjects

With 31 Photos, Sketches, Radio Drawings

How superheterodyne receivers work
 How to remove tubes, tube shields
 Three reasons why Radio tubes fail
 Electrodynamic loudspeaker:
 How it works
 Replacing damaged cone
 Recentering voice coil
 Remedies for open field coil
 Output transformer construction, repair
 Gang tuning condenser:
 Construction of rotor, stator
 How capacity varies
 Restrunging dial cord
 Straightening bent rotor plates
 I.F. transformers—
 What they do, repair hints
 How to locate defective soldered joints

GETTING ACQUAINTED WITH RECEIVER SERVICING

Inside story of carbon resistors
 Paper, electrolytic, mica, trimmer condensers
 How condensers become shorted, leaky
 Antenna, oscillator coil facts
 Power transformer: construction, possible troubles
 Installing power cord
 Troubles of combination volume control, on-off switch
 Tone controls
 Dial lamp connections
 Receiver servicing technique:
 Checking performance
 Testing tubes
 Circuit disturbance test
 Isolating defective stage
 Locating defective part



See For Yourself How I Train You at Home to BE A RADIO TECHNICIAN

More Radio Technicians and Operators Now Make \$50 a Week Than Ever Before

I will send you a sample Lesson, "Getting Acquainted with Receiver Servicing," to show you how practical it is to train for Radio at home in spare time. It's a valuable lesson. Study it—keep it—use it—without obligation! And with this Lesson I'll send my 64-page illustrated book, "Win Rich Rewards in Radio." It describes many fascinating jobs Radio offers, explains how N.R.I. trains you at home for good pay in Radio!

Big Demand Now for Well-Trained Radio Technicians, Operators

There's a big shortage today of capable Radio Technicians and Operators. Fixing Radios pays better now than for years. With new Radios out of production, fixing old sets, which were formerly traded in, adds greatly to the normal number of servicing jobs.

Be Ready to Cash in on Good Pay Jobs Coming In Television, Electronics

Broadcasting Stations, Aviation and Police Radio, and other Radio branches are scrambling for Operators and Technicians. Radio Manufacturers, now working on Government orders for Radio equipment, employ trained men. The Government too needs hundreds of competent civilian and enlisted Radio men and women. And think of the NEW jobs that Television, Electronics and other Radio developments will open after the war.

I Trained These Men



\$200 a Month in Own Business
 "For several years I have been in business for myself making around \$200 a month. Business has steadily increased. ARLIE J. FROEHNER, 300 W. Texas Ave., Goose Creek, Tex."



\$5 to \$10 week in Spare Time
 "I am engaged in spare time Radio work. I average from \$5 to \$10 a week. All this extra money sure does come in handy." THEODORE K. DUBKOFF, Horsham, Pa."

1st Lieutenant in Signal Corps
 "I cannot divulge any information but I can say that N.R.I. training is coming in mighty handy these days." RICHARD W. ANDERSON, (Address omitted for military reasons.)

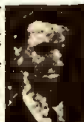

Chief Operator Broadcasting Station
 "Before I completed your lessons, I obtained my Radio Operator's license and immediately joined Station WJPC. I am now Chief Operator." HOLMES F. HAYES, 327 Madison St., Lapeer, Mich."



Many Beginners Soon Make \$5, \$10 a Week EXTRA in Spare Time

The moment you enroll for my Course I start sending you EXTRA MONEY JOB SHEETS that show how to earn EXTRA money fixing Radios. Many make \$5, \$10 a week EXTRA in spare time while still learning. I send you SIX big kits of real Radio parts. You LEARN Radio fundamentals from my lessons—PRACTICE what you learn by building typical circuits like those illustrated on this page—PROVE what you learn by interesting tests on the circuits you build.



EXTRA PAY IN ARMY, NAVY, TOO



Men likely to go into military service, soldiers, sailors, marines, should mail the Coupon now! Learning Radio helps Service men get extra rank, extra prestige, more interesting duties, MUCH HIGHER PAY. Also prepares for good Radio jobs.

Mail Coupon for Free Lesson and Book

The opportunity the war has given beginners to get started in Radio may never be repeated. So take the first step at once. Get my FREE Lesson and 64-page, illustrated book. No obligation—no salesman will call. Just mail coupon in an envelope or paste it on a penny postal.—J. E. SMITH, President, Dept. 3NX, National Radio Institute, Washington 9, D. C.

GOOD FOR BOTH 64 PAGE BOOK SAMPLE LESSON FREE

J. E. SMITH, President, Dept. 3NX
 National Radio Institute, Washington 9, D. C.

Mail me FREE, without obligation, Sample Lesson and 64-page book, "Win Rich Rewards in Radio." (No salesman will call. Write plainly.)

Name Age

Address

City State 4 FR

You Build These and Many Other Radio Circuits With Kits I Supply!

By the time you've conducted 60 sets of Experiments with Radio Parts I supply—have made hundreds of measurements and adjustments—you'll have valuable PRACTICAL experience.

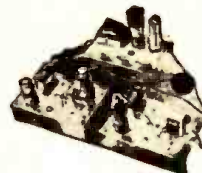

You build this SUPERHETERODYNE CIRCUIT containing a preselector oscillator - mixer - first detector, i. f. stage, diode - detector - a. v. c. stage and audio stage. It will bring in local and distant stations. Get the thrill of learning at home evenings in spare time while you put the set through fascinating tests!

You build this MEASURING INSTRUMENT yourself early in the Course, useful for practical Radio work on neighborhood Radios to pick up EXTRA spare time money. It is a vacuum tube multimeter, measures A.C., D.C. and R.F. volts, D.C. currents, resistance, Receiver Output.

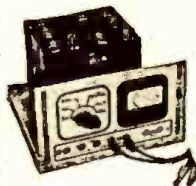

Building this A. M. SIGNAL GENERATOR will give you valuable experience. Provides amplitude-modulated signals for test and experimental purposes.



RADIO CRAFT

▼ AND POPULAR ELECTRONICS ▼

"RADIO'S GREATEST MAGAZINE"



HUGO GERNSBACK, *Editor-in-Chief*
FRED SHUNAMAN, *Associate Editor*
G. ALIQUO, *Circulation Manager*



IN THE NEXT ISSUE

New Anti-Noise Microphone
Meter Errors—Their Causes
We Learn The Hard Way!
Systematic Radio Servicing
Radio Oscillation Remedies
The Complete Multitester



Published by Radcraft Publications, Inc.
Publication office: 29 Worthington Street,
Springfield 3, Mass.
Editorial and Advertising Offices: 25 West
Broadway, New York City 7.
Chicago Advertising Office: Radio-Craft, 520
North Michigan Avenue, Chicago 11, Ill.

RADIO-CRAFT is published monthly, on the
25th of the month preceding that of date; sub-
scription price is \$2.50 per year in U. S. (In
foreign countries, 75c additional per year to
cover postage; Canada, 50c additional.) En-
tered at the post office at Springfield as
second-class matter under the act of March 3,
1879. All communications about subscriptions
should be addressed to: Radio-Craft, 25 West
Broadway, New York 7, N. Y.



Notice of CHANGE OF ADDRESS should
reach us at least one month in advance. Be
sure to give your OLD ADDRESS as well as
the new as without the old address we cannot
find your name in our files.



Foreign Agents

London—Atlas Publishing and Distributing
Co., Ltd., 18 Bride Lane, Fleet St., London,
E.C. 4.
Melbourne—McGill's Agency, 179 Elizabeth
St., Australia.
Dunedin—James Johnston, Ltd., New Zealand.



Text and illustrations of this magazine are
copyright and must not be reproduced without
permission of the copyright owners.
Copyright, 1943, Radcraft Publications, Inc.

CONTENTS

December, 1943

Volume XV, No. 3

Editorial: Electronics and the Public.....	by Hugo Gernsback	133
Radio Month in Review.....		134
Radio Pilot Mine Destroyers (Cover Feature).....	by Hugo Gernsback	138

POPULAR ELECTRONICS

Popular Electronics, Part XI.....	by Raymond F. Yates	136
New Wartime Tubes.....		147

WARTIME RADIO

WACS and Defense.....		146
Light-Phone Used by Nazis.....		152

SERVICING

Meter Errors—Their Causes, Part II.....	by Alfred A. Ghirardi	142
How to Service Radio Speakers.....	by Fred Shunaman	150
RADIO SERVICE DATA SHEET No. 330 Belmont Radio Model 533.....		154

SOUND

Public Address Relay System.....	by Guy S. Cornish	140
"Illegal" Record Players.....		158

EXPERIMENTERS

Make Your Own Key.....		159
------------------------	--	-----

RADIO TRAINING

The Oscillator—How It Operates.....	by Robert F. Scott	144
Radio and the Slide Rule.....		153
How and Why Motors Work.....	by R. H. Rogers*	157
Transmitters for FM—Part II.....	by Jules M. Kleinman	148

DEPARTMENTS

RADIO SERVICE DATA SHEET (See Servicing).....		154
Servicing Notes.....		156
The Listening Post.....		160
Latest Radio Apparatus.....		162
Question Box.....		164
The Radio Experimenter.....		166
Radio Kinks.....		168
The Mail Bag.....		188
Book Reviews.....		191



Hallicrafters Was Ready!

Under the abnormal climatic and operating conditions of war, the Signal Corps SCR-299 communications truck, built by Hallicrafters, is providing peak performance for the Allied armed forces, fighting throughout the world.

Hallicrafters peacetime communications equipment is meeting the wartime qualifications and demands of the Military!

Just as Hallicrafters Communications receivers are meeting the demands of war Today—they shall again deliver outstanding reception for the Peace—Tomorrow!

BUY MORE BONDS



hallicrafters
RADIO

World's largest exclusive manufacturer of short wave radio communications equipment... First exclusive radio manufacturer to win the Army-Navy Production Award for the third time.

Hallicrafters has the honor of being the first exclusive manufacturer to receive the Army-Navy Production Award for the third time! This third award adds a second White Star to Hallicrafters' flag—and stands as a symbol of their great contribution to the cause of freedom.



hallicrafters

THE WORLD'S LARGEST EXCLUSIVE MANUFACTURER OF SHORT WAVE RADIO COMMUNICATIONS EQUIPMENT

... There are TWO classes of electronics as far as the public is concerned ...

HUGO GERNSBACK
Founder

EDITORIAL

Modern Electrics	1908
Electrical Experimenter	1913
Radio News	1919
Science & Invention	1926
Radio-Craft	1929
Short-Wave Craft	1930
Wireless Association of America	1908

ELECTRONICS AND THE PUBLIC

HUGO GERNSBACK

IN EDUCATING the public to electronics, huge sums are appropriated currently in advertising space in practically every medium beginning with newspapers and ending with radio broadcasting. The man in the street may be pardoned if he is somewhat bewildered at the barrage of electronics advertising let loose upon him during the past year, and is having a bit of difficulty in digesting it all.

The layman is led to believe that everything is possible with electronics — and so indeed it is. Unfortunately, he has not been told that there are two distinct classes or types of electronics: Industrial electronics, and home electronics, if I may so term it.

Industrial electronics is that type which is used only in industry, and is normally totally inaccessible to the public. Home or household electronics is that type of electronics with which the ultimate consumer and the man in the street comes in direct contact, that he can see, feel and hear.

It might be a good suggestion for manufacturers to explain these two distinct uses of electronics to the public, to avoid not only confusion but post-war disillusion and disappointment.

When a manufacturer tells in a full-page advertisement that electronics is capable of distinguishing two million shades of color accurately and automatically and recording them on a color graph, the advertisement states the fact truthfully. What it does not say is that such a device can be installed only in a large plant at a huge cost. If the public is not told this, Mr. John Q. Public probably figures out in his own mind that right after the war he can buy such a gadget at the nearest radio supply store for \$3.00, as a present to his wife when she wishes to match pieces of cloth, silk or rayon for her fall house drapes. This is only one example. It

might easily be expanded several hundred fold, and if the present tendency keeps going on for an appreciable period of time, it can be seen that this policy must create no end of mischief in the minds of the non-technical public.

When I refer to two distinct classes of electronics, I appreciate the fact that frequently one class may overlap into the other. Thus, the marvels of the electric eye are such that it can be used in a \$20.00 electronic burglar alarm, as well as in a \$5,000 installation in a steel rolling mill. The point I wish to make is, that the manufacturers should give the public the *whole* story and *all* the information in unmistakable language. This in most cases is not done today.

In connection with this subject, there are a number of other points which also should be taken into consideration by the manufacturers of electronic devices.

A note of pessimism was voiced in a recent issue of FORTUNE magazine, as to many of the present day electronic devices. The magazine observed that many of the electronic appliances might be a bit too stylish for the post-war period. It also pointed out that while the electric eye has been in use for many years and while indeed it might make fine burglar alarms and open our garage doors, such devices should not, by any stretch of the imagination, be called universal or used universally. FORTUNE also bemoaned the fact that the citizens unfortunately preferred opening their garage doors by hand. Other devices, it thought, were much too fancy to use around the home. It further stated that most of the new-fangled and highly talented of the newer vacuum tubes are used only in "new sub-atomic fields of measurement and control." By this the magazine undoubtedly meant industrial uses.

(Continued on page 187)

Radio Thirty-Five Years Ago

In Gernsback Publications

From the December, 1908 issue of MODERN ELECTRICS:

Wireless Telegraphy, by Melville Eastham and O. Kerro Luscomb.

Electrical Valve Tubes. (Illustrated article showing new vacuum tubes invented by Dr. A. Wehnelt, of the University of Erlangen. These were the first oxide-covered glowing cathode tubes.)

Bare Point Electrolytic Detector, by H. H. Holden.

New Detector, by H. Gernsback.

A Wehnelt-Caldwell Interrupter, by Don Banta.

Aerophony on the Great Lakes and Elsewhere. (Illustrated article showing the first

compact DeForest radio telephone transmitter.)

Another Detector, by Harry Dunlap.

Wireless Troubles. Testing and Operation of Receiving Instruments, by L. Spangenberg. (This probably was the first radio servicing article ever published anywhere.)

The advertising section carried among others an advertisement of the new Collins Wireless Telephone Company, of Newark, N. J. An other advertisement featured the following popular new E. I. Co. amateur wireless apparatus:

Universal Detector Stand.—Price \$1.00

Double Slide Tuning coil (with ball bearing slider).—\$2.25.

Adjustable Transmitting Condenser (with six Leyden type jars, which one could snap in and out).—\$2.50.

Transmitting Inductance (Helix type, tunable with clips).—\$2.00.

Variable condenser (with vertical plates that slide in and out, probably the first variable receiving condenser sold to the public.)—\$3.00.

Variable Potentiometer (with two graphite-carbon resistor rods which could be interchanged and with ball bearing contact slider).—Price \$1.50.

RADIO MONTH

News Events of Interest



Signal Corps Photo
Signal Corps soldier and the FM walkie-talkie.

THE SCR-300, latest advance in Army walkie-talkies, a frequency-modulated receiver and transmitter adapted to pack use, was announced last month by Army authorities.

FM has thoroughly proved its superiority for short-distance communication, and has been installed in all tank radios. It is rapidly nosing out AM in mobile police radios in the United States. The new use in a pack set is therefore by no means an unexpected development.

Adopted originally because of supposed greater simplicity, the AM walkie-talkies had many disadvantages. At the frequencies used, local interference and static seriously limited reliability of communication. The old walkie-talkie could not be depended upon to work out more than a mile under bad conditions, though of course ranges considerably greater could be covered most of the time. This is not what Army officers require—a set must be absolutely reliable over a certain distance if military strategy is to depend on it. Therefore the minimum range is the only practical one, and to depend on any communications device for more than that is to gamble with human life.

The old walkie-talkie, thus strictly limited in useful range, had another disadvantage. At night particularly, signals rolling in from a thousand miles or more could jam local traffic. Suffering from limited useful range simultaneously with too great useless sensitivity, the old walkie-talkie had its very definite limitations. Within those limits it performed gloriously, and no doubt there have been many cases when it did noble work at ranges far beyond those commonly attributed to it.

A consistent type of communications unit, whose range could be accurately estimated, which would not be troubled by the spark ignition interference of dozens of tanks, jeeps, trucks and tractors operating all around it, and which would not put signals into places far outside its useful range—where they might be useful to the enemy only—was obviously needed. FM filled that need.

The new SCR-300 is said to have ap-

proximately three times the reliable range of the older pack set it supersedes. It is of course absolutely free from interference from ignition or natural static. The range is the same, day and night, and therefore its performance can be estimated beforehand when laying out plans for any military maneuver.

Another advantage is the adaptability of the new sets to network use. The AM walkie-talkie, with its squealing super-regenerative receiver, was a nuisance when more than two of them were working on the same frequency within range of each other. The super-heterodyne FM receivers of the new sets present no such difficulty to network operation and several can be used on the same break-in circuit.



Signal Corps Photo
The new set with antenna fully extended.

A number of improvements—suggested by experience with the older pack sets—have been incorporated into the new receiver. Not all of these have been revealed by military authorities, of course. One interesting feature is the use of a universal joint in the antenna, which permits operation at full efficiency while the operator is lying prone. Another feature is the provision of headsets as well as the familiar handset of the older pack receiver. Wearing the headset, the operator may be "on watch" for incoming calls, while on the march with both hands free.

The new apparatus weighs about 35 pounds, and may be carried complete by one man. The receiver is slightly larger than in the older sets, but the transmitter is lighter and uses less power for the amount of useful coverage. Thus from a viewpoint of results achieved, the new set may be said to be "smaller and lighter" than the old.

SILENT RADIO receivers are not among the most serious worries of the American public. This is the conclusion reached last month by compilers of a recent Gallup Poll.

Among the questions asked was "Aside from food, what things that you need very much right now for your home or family would you buy if you could get them?"

The place of honor among the answers was held by tires. Other "badly-needed items" were stockings, refrigerators, washing machines, shoes, bobby pins and electric irons. About 500,000 families would buy parts or have repairs made on radios. Tubes were the most commonly mentioned lack.

The figure thus arrived at represents less than 2% of the nation's more than 31,000,000 radio-equipped homes. Even this figure does not indicate that 500,000 families are totally deprived of radio, as in many cases the radio for which repairs are sought may be one of two or more owned by the family. Since at the beginning of the war, the total number of American radio receivers—including motor car sets—was 59,000,000, many of the radios now broken down belong no doubt in the "second set" category.

While these figures are a welcome relief to the scare stories that have been circulated from time to time with various motives, they still represent a serious situation. Should even 1% of the nation's families be without radio, the situation demands correction. The government war agencies believe that one radio per home is of importance in maintaining civilian morale, and the idea commends itself to common sense.

The tube shortage is the greatest single factor in the situation. There is still little hope for great improvement along this line, though attempts to meet at least part of the demand are continually being made.

IN REVIEW

to the Radio Technician

BROADCASTERS who wish to install FM or television transmitters, or modernize their present apparatus as soon as possible after the war, may now use War Bonds as a deposit to reserve equipment for delivery immediately on resumption of peace-time production.

This plan, revealed by General Electric sales executives at a press conference in New York last month, provides for deposits ranging from \$50 in bonds (for a small FM transmitting antenna) to \$15,000, the deposit required on a 500-Kilowatt standard broadcast transmitter. A 50-Kilowatt FM broadcast transmitter may be reserved with a deposit of \$3,500. Since it is impossible to quote prices till after the war, the deposits are reckoned on a kilowatt basis.

A post-war prediction of 500 FM, 750 AM, 100 television and 50 international short-wave stations five years after the cessation of hostilities was made by W. R. David, G.E. transmitter division executive. (Present figures are 900 AM, 53 FM, 9 television and 36 short-wave stations.)

Mr. David also predicted the extensive use of wireless FM networks. Pointing out on a chart the present hook-up between New York, Alpine, Schenectady, Paxton (Mass.), and Mt. Washington, he showed how the addition of automatic relay stations at intermediate points would add to the reliability of service.

"Tomorrow's wireless FM networks," he said, "will differ from those of today in that the relay transmitters will be operated on very high frequencies. They will be small units with highly directional antennas located at strategic high points and probably operated automatically," he explained. "Such stations may be set up as a public utility, similar to the telephone system, or they may be set up as an auxiliary operation of the major networks. In this type of wireless network, the intermediate broadcast stations will not be responsible for passing the program on to the next station."

GREAT STRIDES made by Soviet science and technology, electronics, mineralogy, public health and medicine are as vital as the work of the Red Army in crushing the invading Nazi armies, it was declared last month at a New York congress of Russian and American scientists.

A paper on Soviet developments in the field of electronics was read by Dr. V. K. Zworykin, research director of the R.C.A. laboratories. The famous scientist, himself of Russian birth, is well-known in Russia as well as throughout the world because of his original work in electronic research, especially along television lines. Other participants, including Sir Hubert Wilkins, the explorer, Dr. Kellogg of the Dept. of Agriculture, Professor Dunn, Yale zoologist, read papers on other phases of Soviet war-time science.

Here is the new cold-cathode 300,000-volt X-ray tube, which operates with a one-millionth second shot of 2,000 amperes. Beside the tube is its inventor, Dr. Charles M. Slack of Westinghouse, and in the background, Dr. Herschel Smith, Civilian Aide at the Frankford Arsenal.

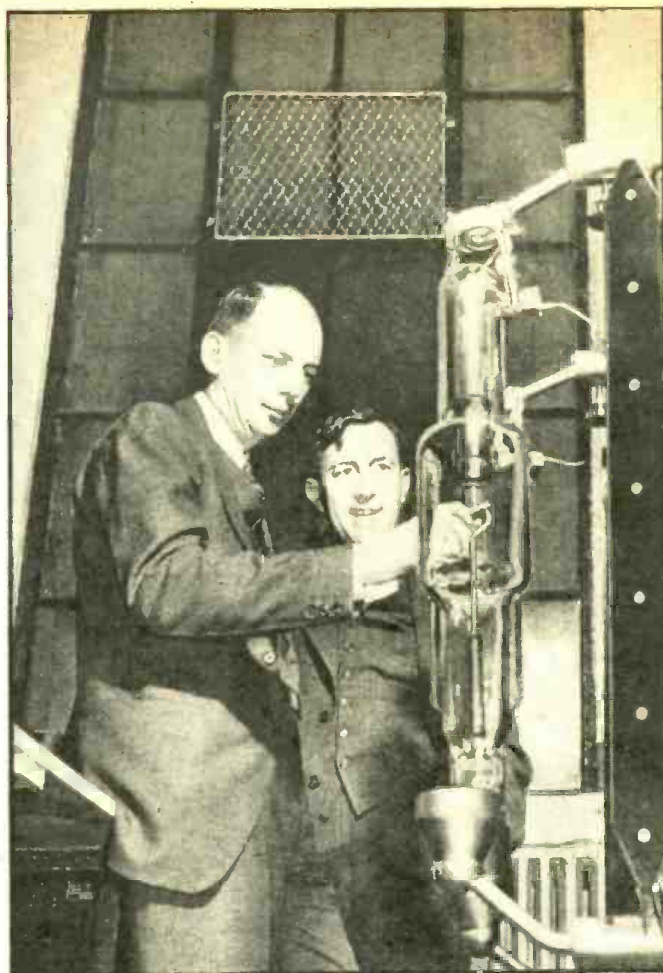

TWIN X-RAY units, each capable of delivering a charge of 2,000 amperes at approximately 300,000 volts in a millionth of a second, will soon be used by U. S. Army Ballistics technicians to study the action of bullets within gun barrels and as they pierce steel armor plate. This research will be directed by Lt. Col. S. C. Fletcher, officer in charge of Frankford Arsenal Laboratory, according to C. V. Aggers, manager of the Westinghouse X-Ray Division, builders of the equipment.

Though a bullet travels at $2\frac{1}{2}$ times the speed of sound, the new x-ray photographic technique permits making two separate exposures of film during the flight of a single bullet. The two x-ray machines will stand side by side, and the elapsed time between two exposures can be varied from a five hundredth of a second to a millionth of a second. Two exposures can also be made simultaneously. Penetration of an inch of steel with the most powerful industrial x-ray machine would require 10,000 times as long because the conventional tube cannot withstand the tremendous amperage necessary for high speed work.

In the new ultra high-speed x-ray machine, high speed x-rays are generated by a series of six condensers and a power transformer. Drawing power from an ordinary 220-volt line, the condensers act as reservoirs, storing up electricity for nearly a minute. In the x-ray tube energy is converted first into electrons and then a fraction of it to a tremendous surge of x-radiation which does its work in one-millionth of a second—almost as long as it takes a car, traveling at 60 miles an hour to move a distance equal to a quarter of the thickness of a sheet of writing paper.

The first experimental tube which made possible ultra high-speed x-rays was developed in the Westinghouse Lamp Laboratories at Bloomfield, N. J., by Dr. Charles

M. Slack and his associates. This tube generated the x-ray-producing electrons successfully for the first time without the aid of the usual heated filament. In tubes where heated elements produce electrons, speed of exposure is limited to about one-hundredth of a second because the power required to make any faster pictures would burn out the inner mechanism. The "cold cathode" principle removes the limit on the amperage that can be applied and hence produces an enormously greater amount of x-rays.

The new high speed tube contains three elements. These include a standard type anode, an oval shaped metal cathode and an auxiliary electrode which serves as a trigger to start the discharge of electrons when the tube is activated. The cathode is first to receive the bolt of 2,000 amperes released by the condensers. Instantly a stream of billions of electrons flows from the cathode to the anode. The electrons on hitting the anode, which acts as a target, release the x-ray energy. The auxiliary electrode directs the flow between cathode and anode.

PRESIDENT of the Institute of Radio Engineers for 1944 will be Hubert M. Turner, of New Haven, it was announced last month by the Board of Directors. He is Associate Professor of Electrical Engineering at Yale University and succeeds Dr. Lynde P. Wheeler, of the Federal Communications Commission.

During the first World War, Professor Turner organized technical instruction for the U. S. Army Signal Corps at the University of Minnesota and Yale. He is noted for his methods of experimental and laboratory techniques in teaching radio engineering. He is a Member of the American Institute of Electrical Engineers.



Lower left.—Starting the motor generators, high-voltage transformers and rectifying equipment needed to operate the huge Cyclotron. Upper left.—A luminescent beam of deuterons, made visible by the ionization of the air in their path. Top.—Watching the operation of the Cyclotron from a safe distance, in the control room at the University of Rochester. Upper right.—A nuclear physicist adjusting the gate leading to the bombardment chamber. Arrow points to the window through which the deuterons emerge. Bottom Right.—Starting the pump that evacuates the acceleration chamber.



The same principles which underlie the motion of electrons in the little tubes of our home receivers may be utilized to make missiles of higher speed, greater relative striking power, and more penetration than anything previously known to man. The tube which accomplishes this is the Cyclotron, which so greatly speeds up the positive particles.



POPULAR ELECTRONICS*

PART XI—ATOMS AND CYCLOTRONS

By RAYMOND F. YATES

THE atomic physicist seeks control over particles bearing positive and negative charges. So vast are the forces with which these particles are associated that purely mechanical methods of control are clumsy and inadequate. The physicist is forced to employ the same forces that appear to form the substance of matter—magnetism and electrostatic charges. When an electron or other charged particle enters a powerful magnetic or electrostatic field it becomes less of a free agent, responds in a predictable fashion. During the past five years, science has provided the physicist with greatly improved methods for producing electric and magnetic fields, and it is in the progress of this nature that the confirmed optimist must anchor his enthusiasm.

Foremost in the mind of the imaginative layman stands the problem of the transmutation of matter; that is the prospect of changing the baser elements into gold, etc. Secondly, the layman thinks of the release of atomic power or the unleashing of the appalling forces that bind atoms together. To a degree, these are indeed fanciful and grossly material aspects of the case but they are no longer without place in the admissions of our more renowned workers. Sir William Bragg, speaking of atomic energy, has said: "The reins may be in our hands tomorrow."

LEAD INTO GOLD—SOON?

As for transmutation, that has already been achieved on a diminutive laboratory scale. Standing between the gold standard and world-wide economic chaos that would be precipitated by a glutted gold market, are only three tiny electrons now held in the valence ring of the atom of lead. If we could knock them off in wholesale style by the use of the prodigious electrical and magnetic forces now for the first time in

* Application for Trade Mark Title, pending in U. S. Patent Office.

our hands, lead would tumble into the throne now occupied by gold and world financial experts would contemplate still another monetary crisis. Inevitable is the dawn of the day when we shall have an artificially created 79-electron metal.

Either wholesale transmutation or the wholesale release of atomic energy at this critical moment in the social history of the world would be lamentable, perhaps definitely fatal to all humankind. The beast in us could not be trusted with such a terrifying weapon as atomic energy. To date we have not even been able to justify our discovery of puny explosives like TNT or smokeless powder. Yet these set free only the mild breaths of rapidly expanding gases.

Yes, the super-magnet and electrostatic field looms large in the annals of human events. The social significance of such things are undreamed of by the average layman. A new and tremendously powerful magnet measuring only 6 x 8 inches and capable of developing a field of 120,000 gauss (the unit used in measuring the strength of fields) was recently described by Prof. Francis Bitter before the American Philosophical Society. This may yet prove to have more social significance than the Magna Charta. By the use of a small water-cooled coil and a current of 12,000 amperes that may be applied hour-on end, Prof. Bitter has exceeded both in duration and magnitude the magnetic fields previously generated by the 85-ton magnetic giant in use at the University of California. This boasted of a field so powerful that a bit of steel sucked off a near-by shelf in the laboratory flew to the pole faces with such speed that it clipped a fingertip off a worker on its way.

THE FIRST ATOM-SMASHER

Sir Ernest Rutherford holds the distinction of being the first man to outwit nature

in her effort to hold the atoms of stable matter in set configurations. This happened back in 1919. So momentous was the announcement that Rutherford, fearing flaws in experimental observation, revealed the results of his work only to his scientific intimates. For the first time it appeared that the identity of matter had been changed by physical rather than by chemical means and Rutherford cautiously concealed his findings until he could be assured of verification. At that time, the means available for accelerating the speed of electrons or other members of the atomic family were crude and somewhat ineffective.

To work the miracle, this thoroughly competent experimenter knew that he must project high-speed particles into atoms and that they would have to strike fairly and squarely before he could hope to disrupt those atoms. He had to use invisible batters to hit invisible targets. Still another requisite of success was the necessity of overcoming the terrific repelling force of a well-knit nucleus. Utterly discouraging also was the prospect of finding and analyzing the new matter that might emerge from a successful experiment for it was obvious that such products would not be present in sensible amounts.

Rutherford used the only then-known method of bombardment. He knew that radium shot off millions of alpha particles in its process of automatic disintegration and that these particles, projected at high speed (or more accurately, under the impetus of high voltage), were really the nuclei of the element helium. He knew further that they had considerable mass and that there was a fair prospect of their disrupting other atoms if they scored direct hits that carried them beyond the layer of valence electrons.

He arranged the tiny speck of radium salt that he had at his disposal in such a way

that the alpha particles it emitted were projected through a small atmosphere of pure nitrogen. Well did he realize that millions of helium nuclei would have to pass into the space occupied by the nitrogen before even a small number of hits could be made. Quite sure was he, however, that in the case where hits were scored the helium nuclei would enter the sacred precinct of the nitrogen core and that the severe electrical forces brought into play on such invasion would result in explosive modification of the atomic configuration of the gas. Precisely such a thing happened. When fair hits were made and helium nuclei entered into nitrogen nuclei, that body, if such it might be called, burst into several bits. One Rutherford recognized as a hydrogen nucleus. This was big news.

IMPROVED METHODS NEEDED

The labor involved in such work was enormous. What was most discouraging was the fact that radium was so costly that millions of dollars worth would have been necessary to produce enough helium nuclei or alpha particles for more sensible results. Hence experimenters from 1920 on have sought a method that would involve no obligations to radium and one that would impart higher speeds to atomic bullets. They also wanted a method that would generate more particles and heavier particles. In place of using a few popguns, they wanted high speed machine guns.

Today the physicist has armed himself not only with better ammunition but with more powerful guns. His bullets are heavier, his means of propelling them in large numbers surpasses radium and he finds himself able to make transmutation a daily occurrence. As projectiles, he now employs one particle that was unknown during Rutherford's pioneer work. It is the deuteron or the nucleus of heavy hydrogen. The proton is also used.

On previous occasions we have been told that high electron speeds may be produced in evacuated glass tubes when the potential (voltage) difference between the electrodes is great. With the advent of the Van de Graaff electrostatic generator capable of supplying 15,000,000 volts, considerable progress has been made in transmutation, using such equipment. Limitations are imposed, however, through the inability of glass or porcelain tubes to resist puncture by high-speed electrons. Then there is also the dangerous matter of high-voltage flashovers that have frustrated so many attempts to exceed high-voltage records.

ELECTRONIC MERRY-GO-ROUND

Out of such necessities and disappointments the cyclotron accelerator was born. Developed by Lawrence and Livingston at the University of California, this gigantic mechanism, the counterparts of which have been installed in six other universities, now stands as the Big Bertha of atomic physics, ready to sling its bullets into matter with smashing speeds. The method involves not only great magnetic fields (to keep the particles in predetermined paths) but also periodic doses of high voltage to impart great speeds.

In the cyclotron, the atomic ammunition (a deuteron or proton, for instance) is permitted to enter a vacuum chamber which has arranged within it two semicircular electrodes that appear like a large pill box cut in two along its diameter. Connected directly to these two insulated electrodes there is what amounts to a powerful radio transmitter of the vacuum tube type. In place of setting up waves in the ether, however, it is the function of this generator to alternately place high-voltage charges on the halves of the "pill box." Thus the charges

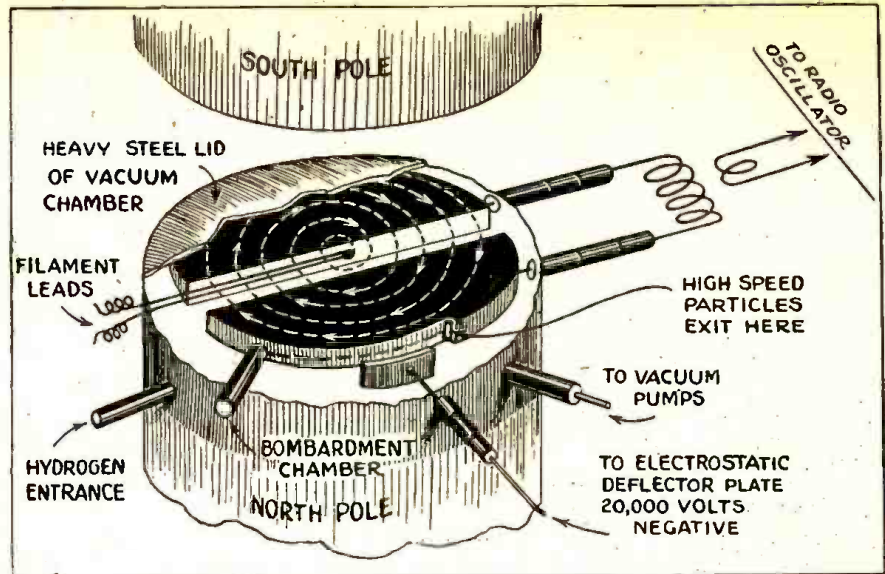

Between the quadrants shown, deuterons, the nuclei of heavy hydrogen, are released. The opposite quadrants are connected to a powerful radio oscillator so that the charges on each shift from positive to negative at the frequency of the oscillator. Thus the deuterons are caused to swing from quadrant to quadrant in a gradually increasing spiral, reaching the outlet at speeds which give them striking power sufficient to break down atoms of matter.

swing back and forth between the halves many thousand times a second.

Even with our modest knowledge of electronics, it will be clear that should a positive particle be introduced in the center of this system it will be drawn rapidly to the negative electrode. If this electrode is hollow, as it is in the case of the cyclotron, the particle, under the action of the magnetic field, will set out on a circular journey. No sooner has it done this than the potential of the negative electrode changes and becomes highly positive, much to the electrical chagrin of the particle which immediately finds itself in a horribly hostile electrical atmosphere. Instantly it dashes toward the opposite electrode. This process is repeated thousands of times a second. On each trip, the particle takes on more energy, more speed. The action has its mechanical analogy in a person on a swing. At the end of each arc described by the swing, the occupant exerts a little more energy which is added to the whole and finally the momentum gained results in greater lift. In the case in hand, the particle, as it gains higher speed, spirals out from the center of the split-pill-box chamber and finally, when its speed is very high, reaches the walls and is eventually led out by a spe-

cial electrostatically excited exit. Once outside, it has the kick of a real atomic mule and is therefore permitted to enter what is known on the cyclotron as the "bombardment chamber" which contains the solid or gaseous element which is to suffer that most modern of all social scourges, loss of individuality.

What has really happened to the bombarding particle is this: each time it made a trip around the circle it was given a little kick and in this way a comparatively small source of voltage (7000) was used to build up speeds that would be rivaled only by the instantaneous application of dangerous, hard-to-handle potentials. It is a new trick reminiscent of those inspired flashes of unmitigated genius that have so beautifully characterized our modern physicists.

WHAT IT CAN DO

Now that we have familiarized ourselves with the operation of the cyclotron, we shall proceed to outline some of the less publicized miracles that have been wrought by its use. The deuterons used for bullets are produced by permitting a small amount of heavy hydrogen to leak into the vacuum chamber through a special valve. In the
(Continued on page 170)

Mr. Yates standing beside one of the largest cyclotrons. Most of the picture is taken up by the magnets; the cyclotron itself is the pancake shaped device at the bottom left.



RADIO PILOT MINE DESTROYERS

By HUGO GERNSBACK

As already reported briefly in my editorial entitled "U. S. Army Wants Radio Ideas," in the October 1943 issue of *Radio-Craft*, the U. S. Army considers it of great importance to obtain a device to locate non-metallic land mines.

I mentioned the fact that as long as land mines were made of metal, it was comparatively easy to detect them and dig them out of the ground so they could do no further damage.

These metallic land mines were formerly located with the so-called treasure finders (which readily detect buried metal) by the exploring military sappers. The Germans, however, becoming aware of what happened, stopped making metal mines, substituting instead non-metallic substances such as wood and plastic; the explosive, also being non-metallic, it follows that the former radio-electric detecting means automatically became obsolete.

Land mines are used chiefly for one purpose only, and that is, to hamper an advancing army in its quick progress over a road or other terrain. In this war particularly, the retreating Germans sowed the roads over which they retreated with thousands of land mines, burying them in the roads, under railroad tracks, and under terrain over which they expected the Allied Armies to advance. Even where hostile armies face each other, such as they did around El Alamein, Egypt, the Germans planted land mines in no man's land. This did two things. (1) It hampered the English 8th Army from making a quick thrust due to the hidden land mines and (2) it gave the Germans quick notice when the English were trying to advance. At El Alamein particularly, the English Army lost a great many lives and valuable tanks when they finally made their advance. Volunteers were called to breach the German lines despite mine fields, and many men and tanks thus were sacrificed. Once a breach was made, the 8th Army then passed through it safely. Nevertheless, as the Germans retreated, they kept on planting mines in all the roads over which they retreated, thus hampering the quick pursuit of the English.

The same condition prevails at the time this is written in Italy where the Nazis bury thousands of mines when they retreat.

To the General Staff these land mines are a terrific nuisance. Never before in any previous war has it become so difficult to quickly pursue an enemy. Moreover the surprise element has been taken away almost entirely from the pursuing army, because exploding land mines give sufficient visual and aural proof of the intent of the pursuer.

No General nowadays wants to squander his men by having them rush pell-mell after the enemy only to pay dearly for it in killed personnel when men either walk or ride over the buried mines. So at present it becomes a long and laborious job to find and dig out these nuisance mines and neutralize them. This is particularly true now when we have no efficient instrument to detect non-metallic mines. This makes the situation increasingly

serious, because it bogs down entire armies which have been deprived of their free movements.

There is one alternative. The General Staff can do what the English 8th Army did at El Alamein, i.e., call for volunteer tanks to breach the line. That, however, again costs not only lives but also destroys valuable tanks. A second choice is to lay down a very close artillery barrage over the road or terrain which is suspected to harbor mines. This also is not only expensive, but such a barrage does not catch all the mines, and it slows up the pursuing army, too.

What then is wanted badly by the Army is a means to advance quickly against the retreating enemy, that is from 20 to 50 miles an hour, irrespective of the mines, and without sacrificing a single life.

I am certain that the plan which I describe herewith solves the problem effectively and it is to be hoped that it will be in use at an early date.

The idea in a nutshell is to use radio-controlled pilot tanks or tankettes with no human being aboard the pilot. The idea is shown graphically on the front cover. A quantity of little pilot tanks each much smaller than even a baby tank, weighing not more than a light automobile, are to be used. These miniature tanks have a small automobile engine and the endless tracks, similar to those used on large tanks. Here the similarity ends.

The pilot tank is constructed for only one purpose, and that is, to blow up mines, and for this reason it must be manufactured cheaply. Indeed, the entire radio-controlled pilot tank can be manufactured for less than a medium-sized aerial bomb. While it looks like a miniature baby tank, it has, of course, no guns, seats, or other trimmings or gadgets which go into the normal tank. But it contains a specially designed radio receiver which can also steer the pilot tank into any direction that it is to travel. Consequently, it can be made to turn to the right, to the left, cut figure eights, and even reverse. On its top there is a special short wave aerial which receives the radio waves from the "control tank" which follows directly in the rear.

A number of these little tankettes are used as pilots and travel ahead of the advancing army. Usually the master tank which controls the movements of the pilots is about 500 yards or less in the rear—a sufficiently safe distance, so that if one of them blows up, the fragments do not injure the personnel that follows.

It will be seen that in order to effectively clear all mines from the road, we need a number of pilots which travel abreast and therefore span the road completely. Inasmuch as these miniature tanks are cheap to build, costing not more than \$300.00 to \$500.00 apiece—a ridiculously small price when it comes to saving human lives—it follows that the loss of a number of these pilots is therefore inconsequential, not only because they

(Continued on page 189)

Facts of the Radio Pilot Mine Destroyer

THE front cover shows graphically the *modus operandi* of the new method in destroying hidden mines, it being almost impossible by radio-electronic instruments to locate the new Nazi non-metallic land mines. At present it is a tremendously dangerous, as well as laborious task for sappers to find them. Often they are killed or injured when exploring for mines.

The remedy: A number of radio-controlled miniature pilot tanks—called tankettes—precede the advancing army. No human being is in the pilot, which is operated at a distance from a control car or tank in the rear—all by radio.

The tankettes are small and cheap to manufacture, at a cost not greater than a small car. They can be built quickly. Result: They can be sacrificed and will save hundreds of lives. Even ordinary jeeps can be converted into radio-pilot-mine destroyers, as is also shown on our cover illustration. These radio pilots have only one purpose, and that is to be blown up by buried mines. A number of pilots advance over the mined road and as fast as they are blown up they are shoved aside. The mechanized army and the following infantry can now advance at high speed, practically without stopping. If the advance is fast enough, it will be difficult for the enemy to lay new mines because there will be no time to do so. Most important, no lives are lost.

NAZI LAND MINES

In order to better understand Mr. Gernsbach's article, we show on the opposite page the main features of the German land mines which have assumed an importance all out of proportion to the cost involved. They are the chief reason why the allied armies cannot pursue the enemy quickly or efficiently.

Illustration 1 shows what happens to trucks when they hit buried mines. Not

only do they raise havoc and often destroy trucks with supplies, completely by fire and otherwise, but there are always casualties. 2.—This shows a flame-throwing mine equally effective against tanks, as well as trucks. 3.—A buried anti-tank mine. The Nazis used metal mines in the past, easily located by electronic means. Now the mines are made of wood or plastics, or a combination of both. 4.—Another nasty Nazi mine

designed to kill advancing infantry. 5.—The radio-control tank described in the above article. This tank follows the pilot mine destroyers. It shows operator at radio-control keyboard.

Illustrations 1, 2, 3, 4 by S. W. Clatworthy, London Sphere; Copyright, King Features Syndicate, Inc.
5, Copyright RADIO-CRAFT.

Fuel Tanks ruptured & dislodged spraying blazing Petrol!

Cab Bonnet Wings & Tarpaulin torn off

Trucks burnt out with steelwork distorted

① About 4 Tons Lifted 2 Feet LADEN TRUCK

About 2 tons Flung over UNLADEN TRUCK

Leg Wounds from Splinters piercing Floors

Men injured by violent jostling Some Flung out TROOP TRUCK

FLAME-THROWING MINE

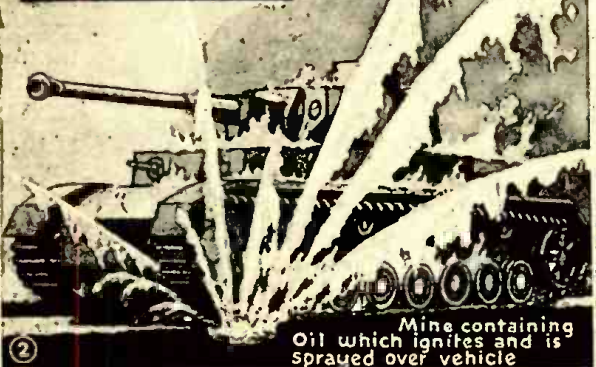

Mine containing Oil which ignites and is sprayed over vehicle

ANTI-TANK MINE is broad and flat hurling whole explosive force and maximum splinters upwards

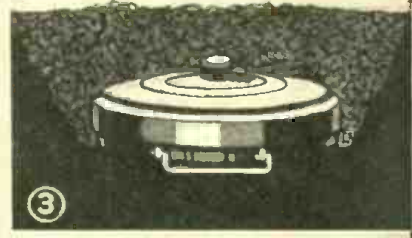

ANTI-PERSONNEL MINE springs to shoulder height before exploding

Cylindrical canister drives maximum splinters levelly all round

Detonating horns

Trip cords may be fitted

④

RADIO CONTROL KEY BOARD

⑤

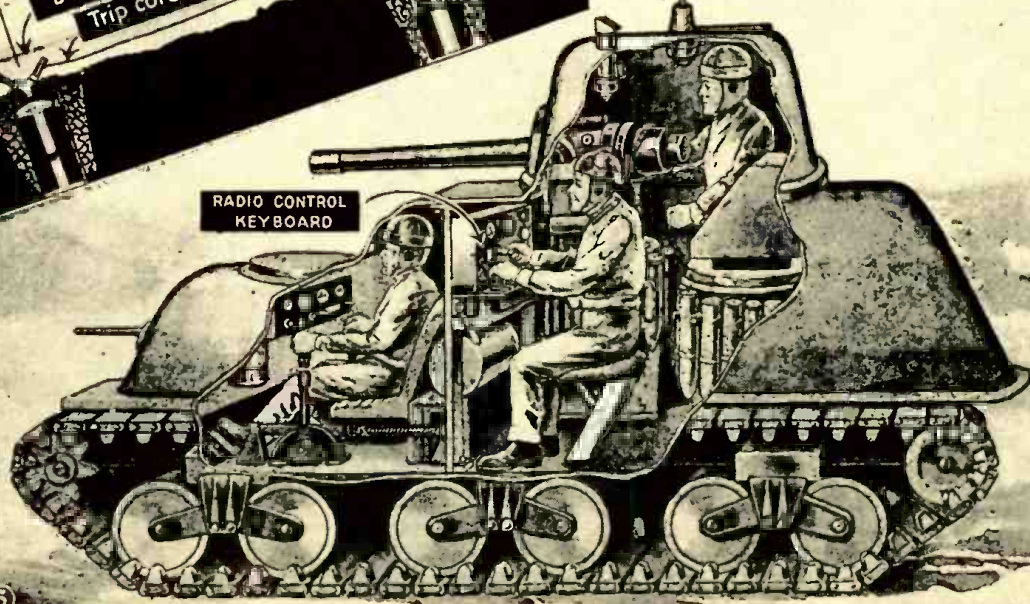

Rayburn

Public Address Relay System

By GUY S. CORNISH



A completely portable pickup unit which can be moved rapidly and without the accompaniment of trailing wires is indeed a useful device in public address pickup of outdoor events. The unit shown at the left— together with its designer and the author of this article, Mr. Cornish— is such a pickup and retransmitting station. It has considerably more output than the pack-type sets used in convention halls, and gives excellent results over distances of more than three hundred feet. Such ranges are usually near the practical maximum in public address work, for reasons given in this article.

EVERY radio man who has had any part in the setting up and operating of sound equipment at field-meets, football games and other public events where large crowds are present has been confronted with that ever-present problem of having someone trip over the microphone cable.

The writer has followed the sound business for past fifteen years and personally encountered these cable difficulties. He conceived the idea of eliminating the cable entirely by using a small low power transmitter, powered by batteries, and carried by the announcer. This relays his voice to a special receiver pick-up, located near the public address amplifier.

The output from the receiver is fed into the amplifier and after amplification delivered by the loud-speakers so that all present may hear.

A small transmitter, using a 1C6 tube, was constructed with a circuit similar to that used in the wireless record players. The output was not sufficient to over-ride atmospheric noises and when the signals were amplified to levels high enough to operate loud-speakers, results were very unsatisfactory.

A request was made to the FCC at Washington for permission to carry on some experiments in this field with a transmitter

of suitable power, but they immediately turned thumbs down on the request, stating that no such service had ever been authorized.

RADIO STATION W8XWI

A two-year correspondence finally resulted in a hearing and the writer appeared before them with a full description of the new service he desired to establish.

About three months later a construction permit was granted for a small transmitter to operate on 310 megacycles with an output not to exceed one watt.

After construction was complete, a class II experimental license was granted and the call letters W8XWI were assigned to the station.

The first transmitter placed in this service was built in pack form and carried on the back of the announcer.

A picture of this first official public address relay station was published in *Radio-Craft*, May 1941 issue.

While the operation of this equipment was satisfactory as long as the crowd remained at a distance from the announcer, when they crowded around him the UHF signals were absorbed to such an extent that the loud-speaker volume would fall below suitable levels.

To overcome this difficulty the transmitter was mounted on a tripod and the antenna changed to a fork or end-fire type, which being directional, permitted the beaming of the signals to the receiver.

Another advantage gained by this arrangement was the fact that the antenna was well above the heads of the people and the shifting of the crowd did not affect the signals.

This station with a wave-length of a little less than one meter, operates on what is known as line-of-sight transmission and best results are obtained when the path between the transmitter and receiver is free from obstruction.

The question usually asked is, how far will the signals carry? This can be answered by saying that in ninety-five percent of all occasions where this outfit is used, the distance covered is less than three hundred feet.

In any type of sound service where loud-speakers are located three hundred feet from the microphone, the time required for the sound to travel through the air from the speakers to the mike gives the impression of an echo. This is very annoying to the announcer and for this reason every attempt is made to keep this distance as short as possible.

On one occasion where the announcer was covering an athletic contest on a recreation field, a clump of bushes stood between him and the receiver and the radio waves were absorbed or reflected to such an extent that satisfactory operation was impossible. When the antenna was turned in such way as to direct the waves against the recreation building at an angle, the reflected waves reached the receiver and perfect results were had from the loud-speakers.

On another occasion it was found that the wave when striking a concrete wall at an angle were reflected, but when striking squarely they penetrated the three foot thick wall and operated a public address system inside the building.

The transmitter will deliver about one-half watt when two 958 acorn tubes are used with 135 volts on the plates. With two 955 tubes using 180 volts on plates, an output of about three-quarters watt can be expected.

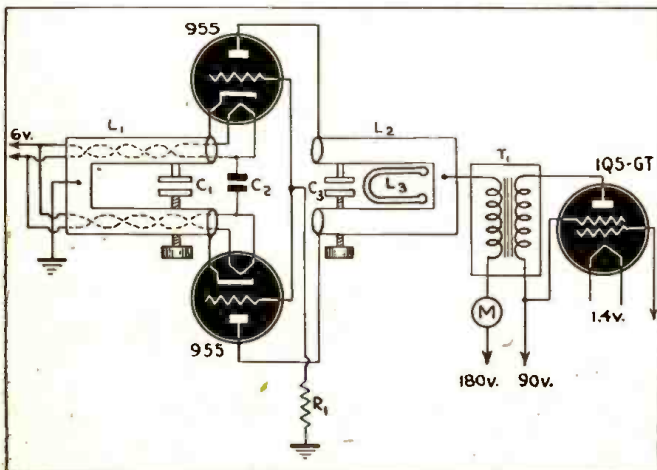

Fig. 1. The transmitter unit is constructed the best short-wave style, using transmission-line tuning elements and acorn tubes. Presumably other tube types can be used while acorns are unavailable, and possibly the whole transmitter could be constructed to work with a 1.4-volt filament supply.

This station, small as it is, comes under the regulations of the FCC and must be handled by a licensed commercial phone operator.

The FCC requires some means of frequency control on all transmitters and for those working on frequencies above 300 megacycles probably the best method is the use of tuned lings in both the plate and cathode circuits.

If these are rigidly constructed and well insulated, the frequency will remain constant over long periods of time. Their appearance and relative positions are easily seen in the two photographs.

One precaution must be taken in mounting the porcelain insulators to the aluminum chassis. If these are screwed down tight, the chances are they will crack and the copper tubes will not be held rigid enough to insure frequency stability.

The best way to prevent this, is to cut a piece of felt the shape of the base of the insulator and place it between the insulator and the aluminum chassis before tightening the screws. Any variation in the porcelain caused by temperature changes will be taken up by the felt pad and damage to the insulators avoided. These precautions must be taken, as frequency can be varied only too easily at the frequency used.

The chassis is formed from a one-sixteenth inch aluminum sheet by bending it over a wooden block. It measures two inches high, four and one-half inches wide and ten inches long. The circuit is shown in Fig. 1.

The plate tubes are made from hard-drawn copper tubing, sixteenth-inch wall and outside diameter, three-eighth inch. They are spaced three-quarters inch between centers and are four inches long.

The plate tuning condenser is the usual two plate type, one of the plates fixed to one of the tubes and the other soldered to a machine screw, which is threaded through the other tube so that the distance between them can be varied by turning. These plates are three-quarters inch in diameter.

The two acorn sockets are mounted at one end of the chassis and each plate tube is connected by a short stout wire to the plate spring on each socket.

The far end of the tubes are connected by a heavy copper yoke, supported on a porcelain insulator.

The two grid leads on the acorn sockets are connected together and then grounded to chassis through a 25,000 ohm resistor.

At the opposite end of the chassis is shown the modulator transformer and IQ5GT.

The cathode tubes are mounted under the chassis and are identical in size and spacing to the plate tubes with the exception of the length, which is seven inches.

The cathode tuning condenser is constructed the same as the plate condenser but the diameter is one-and-one-half inches.

From lower left around to upper right the photos are: The speech amplifier unit; the two-tube receiver; a top view of the transmitter unit and—up the side column, a side view of the same. Above it is another view of the speech amplifier.

The construction stresses extreme stability and rigidity, a necessity in U.H.F. apparatus.

Fig. 2. The receiver uses an acorn-type detector in a standard U.H.F. circuit. Sensitivity and output are ample for the ranges over which the instrument is to be used.

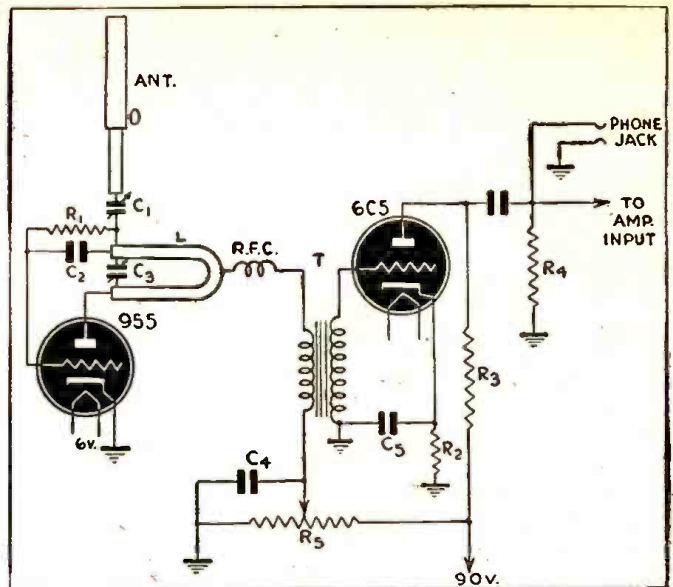

Between the acorn sockets is a small condenser, useful in tuning the filaments when 958 tubes are used.

The drawings and photographs should give an idea of how the parts are assembled.

If a carbon microphone is used, one end of the microphone transformer secondary is connected to the grid of the IQ5GT tube and the other end is grounded to chassis.

TWO-TUBE RECEIVER

The receiver pick-up, removed from its case, is shown in the photograph, also its two cables. Fig. 2 is the schematic of this unit. The one with a four prong plug plugs into the side of the public address amplifier to draw filament and plate current and the other cable with a phone plug feeds the signals into the amplifier input jack.

The dimensions of this receiver pick-up can be roughly judged by noting the size of the phone plug.

Of course, any receiver that can pick up 310 mc. can be used, but in order to make this article complete I have furnished a drawing, showing the circuit used in these experiments.

On the front panel are shown two knobs, the bar knob on left controls the plate voltage on the 955 detector and the knob on right is the tuner.

The jack at bottom of panel is for head-phone reception when necessary.

While a carbon microphone may be used in some classes of service, where the crowds are large and the noise level high, a good crystal microphone will give far better results.

Unfortunately the output from a good crystal mike is low and it must be built up before it can be fed into the modulator tube.

For this purpose, a two-tube speech am-

plifier is required and a circuit diagram is shown, also a photograph of the one used in these experiments.

A volume control enables the operator to control feed-back when operating at various distances from the loud speakers.

The microphone used in these experiments is the Turner model 22X with tilting head. The tilting head feature makes it perfect for interviewing, as the head can be turned back and both sides of the conversation received.

Originally this was considered as merely an experimental model and a base for further development, but for nearly a year the writer has been instructing in radio and mathematics at the Fifth Command Signal Corps School, in Cincinnati and during this period has had no time to do experimental work of any kind.

However, as the equipment operates very well in its present state of development, a detail description of same may be of interest.

(Continued on page 184)

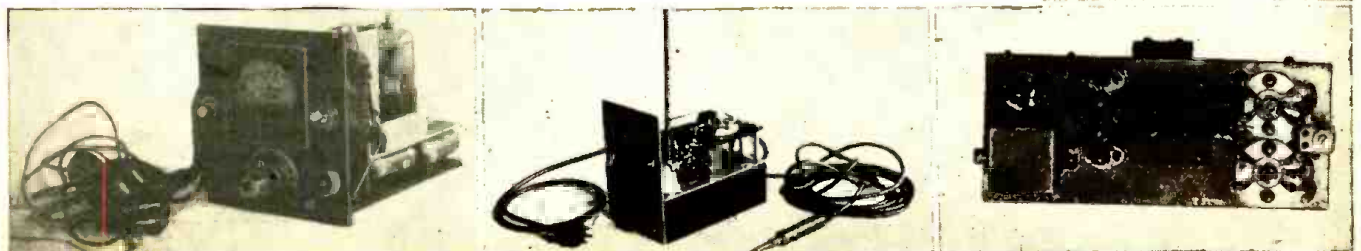
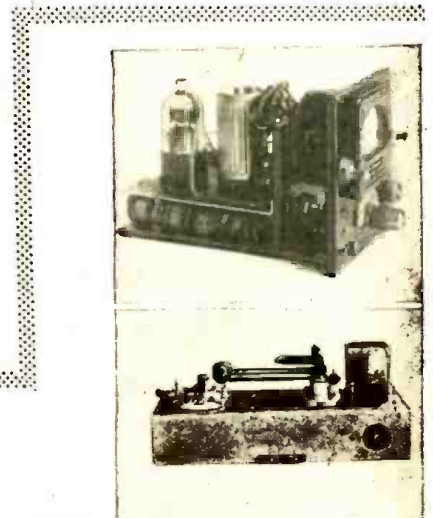



METER ERRORS—

PART II—READINGS AND INTERPRETATIONS

THERE are two ways in which the inherent accuracy (or inaccuracy) of an electrical indicating instrument may be stated. They are:

1. The maximum probable error expressed as a percentage of any individual indication, or

2. The maximum probable error expressed as a percentage of the full scale value of any specific instrument range.

Which of these methods is the more desirable and practical one by which to judge and express instrument accuracy, and why? It might seem that the first is preferable, for the instrument user is always most interested in the accuracy (or inaccuracy) of the individual indication he obtains for a particular measurement he is making. Therefore, if the actual error data (in per cent) for every specific instrument indication are supplied him, he has just the information he wants. But if this method of expressing inaccuracy is employed, no one, single inaccuracy figure gives a true statement of the inaccuracy that exists at various points over the entire range of the instrument, for the inherent inaccuracy of any instrument varies widely at different parts of the scale. For example, the graph of Fig. 1 shows that the inaccuracy at the 1.0 volt point on the scale is different (and very much higher) than that existing at the 6.0 volt point, etc.

Consequently, if inherent instrument inaccuracy is to be fairly and comprehensively expressed by the first method, the instrument manufacturer has to furnish, in graph or tabular form, the value of inaccuracy which exists at almost every scale division. This would require—for each individual instrument—complete, accurate calibration and plotting of a graph for each scale range. Obviously, this is economically impossible for instruments that are to be sold at the low competitive prices existent in the radio and electric service instrument field. Instruments so calibrated are used in other lines of work, where cost is not so important and high accuracy is necessary.

An alternative to this would be that the manufacturer state the inaccuracy existing at the most inaccurate part of the scale, and specify this as the *maximum possible inaccuracy* in readings taken at any point on the scale. This would not be fair to the manufacturer and his instrument, however; much more inaccuracy usually exists in the lower fifth of the scale (a small portion, not greatly used) than does at any other part. See Fig. 1. If this method were used, the entire instrument inaccuracy would have to be judged by that existing in a very limited, little-used portion of the scale; the manufacturer would be penalizing his instrument unfairly.

The foregoing point is clarified by considering the instrument for which the graph of Fig. 1 was made. The inaccuracy at the 1.0 volt point on the scale is actually about 0.17 volt, or 17% of the indicated value, whereas over the whole portion between about 4 volts to 10 volts on the scale (60% of the total scale length), the inaccuracy does not exceed even 0.8% at any

point. By the foregoing method of expressing instrument accuracy, the manufacturer of this particular instrument would have to state that it is 17% inaccurate. Besides being ruinous to its sale, such a high inaccuracy rating is actually untrue; over the upper 60% of the scale (the very part most used), no indicated reading would be more than 0.8% in error, and even over the next lower 20% of the scale, the errors would all be under 6%!

A.I.E.E. DEFINITION OF ACCURACY

Instrument manufacturers ordinarily state the accuracy of their indicating instruments on the basis of the maximum error which

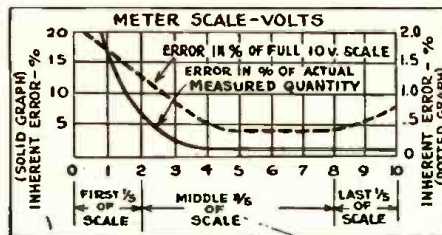

Fig. 1—The rated error of an instrument plotted against possible error at given settings.

may occur at any part of the scale, but because of the reasons just discussed, this error is *not* expressed in terms of the individual indication at which it occurs. Instead, it is stated as a percentage of the full-scale value of the instrument range under consideration (in instruments having the zero at a point other than at one end of the scale, the sum of the full-scale values to the right and left of the zero point is used).

This method of defining a meter's accuracy gives a lower numerical value for the inaccuracy figure—but it is entirely correct; it is simply a more advantageous and fair way of expressing it, much more in keeping with the conditions under which indicating instruments are actually used. It is in accordance with the Standardization Rules of the American Institute of Electrical Engineers and also the American Standard of Electrical Industry Instruments approved by the American Standards Association. This type of accuracy rating applies to the indicating instruments of all manufacturers. The error of indication is the difference between the actual indication and the true value of the quantity being measured.

A positive error (+) denotes that the indication of the instrument is greater than the true value; a negative error (—) indicates that it is less than the true value.

When a manufacturer states that an instrument is accurate to within a certain per cent of the full-scale value of the range under consideration, it is understood to apply to the entire scale. In instruments which have a uniformly-divided scale, this really amounts to saying that no scale division mark is out of its proper position by more than a certain linear distance (this linear distance being equal to the total

scale length in inches multiplied by the per cent accuracy).

If the instrument scale were divided into 100 divisions, the error could be expressed in terms of scale division (2 for 2%, 5 for 5%, etc.). Therefore, the error would be expressed as so many per cent of full-scale angular deflection. This is particularly important, as we shall see later, in computing allowable error in ohmmeter ranges, on which the divisions usually are not uniformly spaced.

"ACCURATE TO 2 PER CENT"

In accordance with this method of rating instrument accuracy, when a manufacturer specifies that a certain indicating instrument is inherently accurate to within 2%, he always means that if the instrument is used under the operating condition for which it was designed, the actual indication of the instrument itself (not as the observer may perhaps carelessly read it, thereby introducing additional observational errors) for any reading within its various ranges is accurate to within plus or minus 2% of the full-scale value of the range used. It does not mean that the error is necessarily as large as this for every point in the scale—it simply means that the error does not exceed this value. To make this clear, consider the following examples:

Suppose a certain voltmeter has a 100-volt range (with a uniformly-divided scale up to 100 volts) and that its accuracy is stated to be within 2%. This accuracy rating means, simply, that for any voltage measurement made with this range, the indication of the instrument pointer will be in error *not more than* (it may be less) plus or minus 2.0 volt (2% of 100). For instance if the indicating instrument reads 100 volts for a measurement, the true voltage may be as much as 2.0 volts above (or below) this; i.e., some value between 98 and 102 volts. If the reading happens to be 50 volts, the true voltage may be as much as 2.0 volts (still 2% of the full-scale value 100) above or below this, i.e., between 48 and 52 volts.

If this same instrument has a 50-volt range, the same 2% accuracy figure applies, but since it now applies to the full-range value of 50 volts, the possible maximum volts error at any point on this scale is plus or minus 2% of 50, or plus or minus 1 volt. For instance, if a reading of 50 volts is obtained, the true voltage may be as much as 1.0 volt (2% of 50) above or below this value, i.e., some voltage between 49 and 51 volts. For a scale reading of 20 volts, the true voltage may be some value between 19 and 21 volts, etc.

Remember, then, the following important fact:

The inherent instrument accuracy figure stated by the manufacturer is based on the full-scale value of the particular range used and not on the actual value of the reading (except in the one case where the reading happens to be the full-scale reading).

Although a voltmeter was considered in the illustrative example above, the same holds true for ammeters, milliammeters, etc.

THEIR CAUSES

By ALFRED A. GHIRARDI

(Ohmmeter accuracy will be discussed later.) The same also applies to those A.C. instruments having non-uniform scales. Their stated accuracy in per cent is based on the full-scale value of the range considered, regardless of at what point on the scale the pointer actually is during the taking of the reading. However, since the divisions at one end of such scales are very crowded (except in rectifier A.C. instruments), to avoid large observational errors, the proper ranges on such instruments should be employed so the reading will never occur at the very crowded portion of the scale.

HOW ACCURATE NEED THEY BE?

Remember that the manufacturers of commercial radio and electronic equipment design and build their equipment with most resistor and condenser value tolerances as large as plus or minus 10 to 20 per cent, and about 10 per cent for currents and voltages. Thus, in the case of a 20 per cent tolerance, a resistor marked 100,000 ohms could have any actual value between 80,000 and 120,000 ohms and still be between the manufacturer's tolerance limits. A plate voltage having a theoretical value of 200 volts could have an actual value of from 180 to 220 volts and still be above suspicion.

It is not intended to imply that every voltage reading, or every resistance reading, taken during the course of analysis of the circuits of such apparatus can differ as much as 10% from the value indicated on the manufacturer's circuit data and still be considered normal and acceptable. The wide latitude usually permissible is brought into the discussion here to emphasize the fact that extremely close accuracy, say as close as $\frac{1}{2}$ of 1%, is not essential in the measurements or in the instruments employed in ordinary radio and electronic service work.

However, although the allowable tolerance in radio and electronic equipment is usually 10 to 20 per cent for the values of most resistors and condensers, and about 10 per cent for most currents and voltages, the instruments used for measuring them should have greater inherent rated accuracy than these values for, as we shall see, several other inaccuracies (such as observational errors, etc.) in addition to those inherent in the indicating instrument itself may be introduced and affect the reading obtained.

RATINGS OF TEST INSTRUMENTS

Most good-grade permanent-magnet movable-coil D.C. indicating instruments used in standard service test equipment are rated at 2% inherent accuracy (readings accurate to within $\pm 2\%$ of full-scale value—for any range). This does not mean, of course, that the inaccuracy is necessarily as large as this over the entire scale—it means that the inaccuracy does not exceed this value. In fact, some manufacturers try to beat this accuracy by about one-half, so that

even after the instrument has been shipped and received by its ultimate user, its accuracy will still be well within the 2% value.

Even though they employ the same type of permanent-magnet movable-coil D.C. movement just mentioned, most good-grade A.C. rectifier instruments are inherently accurate to within only $\pm 5\%$ on their A.C. ranges, due to variations in rectifier resistance, temperature, humidity, etc. For D.C. measurements, they may be expected to read accurate to within $\pm 2\%$ of full-scale value.

Such high inherent accuracies must not be expected in very low-priced or shoddily constructed instruments, in instruments which have been abused, or in instruments subjected to abnormal temperatures of humidity.

PERMANENCE OF ACCURACY

One important characteristic of electrical instruments is given all too little thought by users. This is the *permanence* of their accuracy. A poorly made instrument may have an inherent accuracy within 2% when made, but a year later this may have increased to 8 or 10%. The specified degree of accuracy should be maintained over a period of years—assuming, of course, that the instrument is not abused by constant overloading, rough handling, etc. This means that it should be well-designed and built of good materials. Since the serviceman cannot readily determine this even by inspecting the interior of an instrument when he purchases it, he must rely upon the integrity and reputation of the manufacturer. He must remember, too, that as a rule, among the various instruments of any manufacturer the more he pays for an instrument, the better its materials and the more permanent its accuracy are likely to be.

The design of the instrument should insure sufficient rigidity, strength and permanence of adjustments. The materials employed in it must be suitable, properly tempered and assembled. For example, even though the finest magnet steel is used, the field strength of the permanent magnet will not remain constant unless the magnet has been heat treated correctly. The same applies to the spiral control springs—fatigue and aging will result (manifesting itself in a "drift" of calibration) if they are not properly heat treated. The electrical

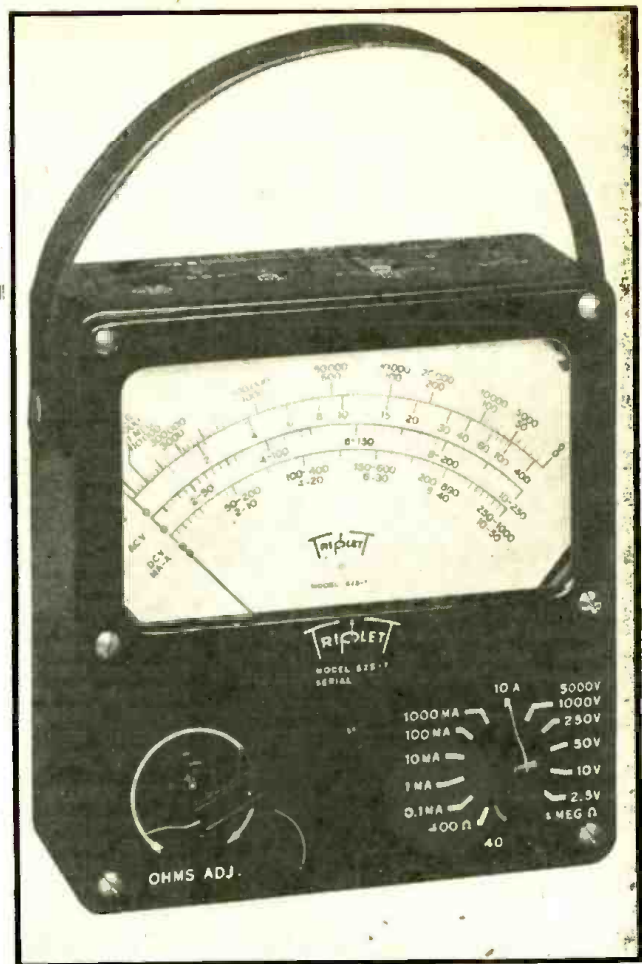

A portable test meter of the type commonly used by radio servicemen. The various ranges are changed with a tap-switch, provision being made for voltage, current and resistance measurements.

windings must not change with time; the pivots must not rust, etc.

These few examples show upon what complex conditions the reliability and the permanence of accuracy of the Serviceman's electrical indicating instruments depend, and hence to what a large extent the price, manufacturer's integrity, experience, factory processes and test facilities are important.

REGION OF SCALE AND ACCURACY

As was pointed out previously, calibration of medium-priced indicating instruments of the types commonly used in test instruments is usually checked at only one point (between $\frac{3}{4}$ and $\frac{3}{8}$ of full scale). The actual error is not uniform over the entire scale, but in permanent-magnet movable-coil instruments varies more or less as shown in the typical graph of Fig. 1. Notice that the actual error (in volts) over the first $\frac{2}{5}$ of the scale is much higher than at any other point. In this region (especially over the first fifth of the scale) the actual error, when expressed as a percentage of the quantity being measured, may become very appreciable. For example, even though a 100-volt A.C. voltmeter having an accuracy rating of 2% (meaning 2% of full-scale value) is used, voltage measurements made with it and involving small deflections at the extreme low end of the scale might actually be 50% or more in error. In this case "2% of full scale" means 2 volts allowable error, for readings taken anywhere on the scale. For a 50-volt reading (made at mid-scale) this 2-volt allowable error rep-

(Continued on page 175)

The Oscillator—

The oscillator is the beating heart of radio. Without it no broadcast transmission would be possible, and such receivers as the superheterodyne could not exist.

By ROBERT

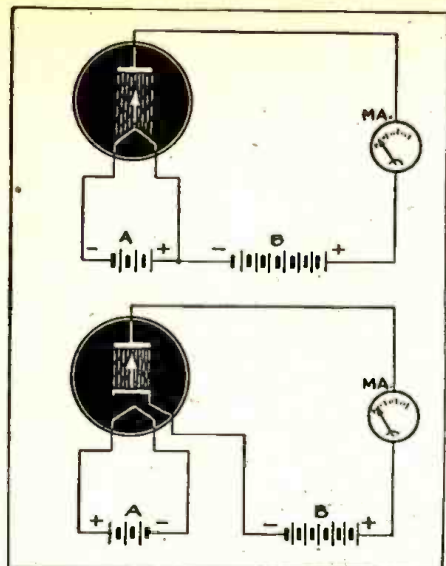

Fig. 1 (top), and 1-a (bottom)—Electron flow from filament to plate in a vacuum tube, and the same action in an indirectly-heated "cathode-type" tube a later development.

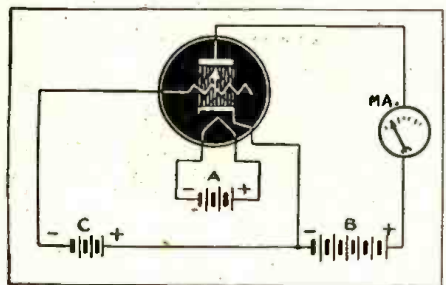

Fig. 2—Circuit of a triode, showing the voltage sources which create conditions for electron flow, with the grid in control of the current.

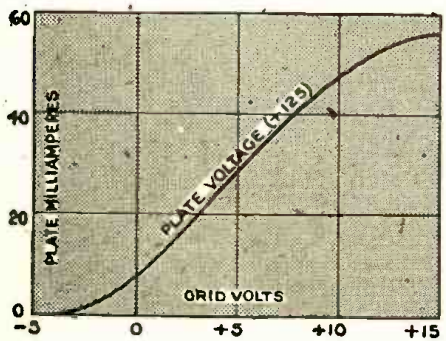

Fig. 2-a—How variations in grid voltage change the amount of current flow in the plate circuit, plate voltage remaining constant.

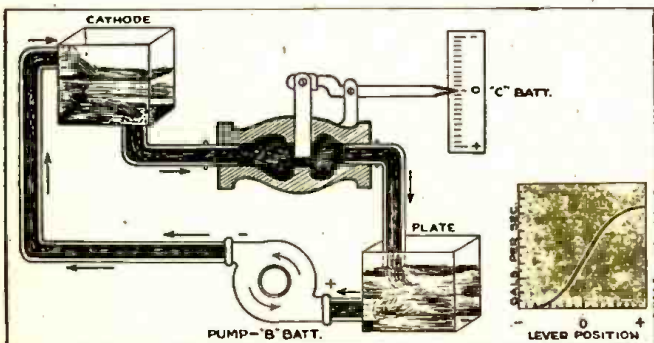

Fig. 2-b—Hydraulic analogy of the electron tube, showing effect of grid. Fig. 2-c—(Graph in corner.) A hydraulic application of the Fig. 2-b graph, with gallons of water per second instead of milliamperes.

TO fully understand the operation of many types of present-day radio and electronic equipment, it is necessary to be familiar with the fundamentals of the vacuum tube oscillator in all of its forms.

The most elementary vacuum tube is the diode, which is composed of a cathode or heater and a plate. The filament of the tube is a strand of tungsten wire or ribbon supported vertically by insulators. Each end of the filament is brought out at the base of the tube to a pin. There are several disadvantages connected with the use of this type of filament, which is often spoken of as a "directly-heated cathode." When alternating current is employed for heating purposes, the reversals of current cause unwanted fluctuations in the plate current especially when the plate return is made directly to one side of the filament.

TWO KINDS OF CATHODES

To overcome this disadvantage, tube designers have produced what is known as the indirectly-heated cathode tube. This type of cathode consists of a metal cylinder coated with oxides of barium and strontium. These materials emit electrons very readily when heated. A hollow tube of ceramic material that is a good conductor of heat is inserted in the coated cathode and a heater wire placed in the hollow of this tube. When a current is passed through the wire it is heated to incandescence and the heat transmitted to the ceramic insulator and the coated cathode. The metal of the cathode is connected to a pin at the base of the tube so that any grid or plate returns may be made to it.

Figure 1 illustrates a two element tube or diode with a directly heated cathode and Fig. 1-a, one with an indirectly heated cathode. When a voltage is applied to the filament or cathode-heater the temperature is raised to a point where electrons are emitted and swarm around in the evacuated space near the cathode. If the plate is made relatively positive by connecting the positive side of a battery to it and the negative side of the battery to one side of the filament (or the cathode of an indirectly heated tube), the negatively charged electrons are attracted to the plate. These electrons flow off through the battery and

back to the filament or cathode. It should be noted that this flow of electrons is from negative to positive and should not be confused with the "conventional" conception of current flow which is said to be from positive to negative.

In the diode, the current flowing in the plate circuit depends on two factors; the plate voltage and the filament temperature. The filament voltage must remain fairly constant for best re-

sults and in many cases the plate voltage cannot be readily changed to control the current. This type of tube therefore has its limitations in the field of radio and electronics. By inserting a metallic screen or spiral of wire between the plate and cathode, or filament, and connecting this screen or "grid" to a source of negative voltage, it will repel some of the electrons and prevent their passage to the plate. If the grid is allowed to become positive the electrons will be drawn toward the grid, but due to the spaces in the grid and the strong attraction that the plate has for the electrons, most of them will pass through and on to the plate. This positive potential on the grid will accelerate the electrons in their passage to the plate and will therefore cause a larger number of electrons to reach it per unit of time, resulting in increased plate current. We can see that the grid may be regarded as a valve for the flow of plate current. If the grid is made sufficiently negative, the plate current will be cut off completely. This voltage is critical for each value of plate voltage and is called the cut-off voltage.

To aid the student in understanding this action of the grid and its influence upon the plate voltage; a hydraulic analogy has been made. The grid of a vacuum tube acts very much like a valve in a water pipe line. In Fig. 2-b, the higher reservoir represents the filament and the plate is represented by the lower tank. The valve in the connecting line between the two tanks acts like a grid. When the valve is closed in a downward direction, this corresponds to the action of the grid with a negative voltage applied to it. As the valve is closed in this negative direction the amount of water reaching the plate will decrease until it has been cut off entirely. It would be very simple to make a graph showing the relationship between the motion of the valve in a positive or negative direction to the flow of water per second. Fig. 2-c shows how this graph might look. The amount of water drawn through the valve in any unit of time depends directly upon the suction of the pump.

In the vacuum tube, the grid located between the plate and the filament, or cathode, may be made negative or positive as desired and will thus control the flow of current as long as the plate potential remains constant. The voltage on the plate has its counterpart in the pressure of the pump in the hydraulic system.

A HYDRAULIC ANALOGY

In Fig. 3, we have a circuit that is capable of producing oscillations for a very short period of time. For a detailed description of the action of this oscillator see the article by Milton S. Kiver, in the July issue. This oscillating circuit consists of a charged condenser and a coil of wire. This coil should be wound on a surface which is as near a perfect insulator as possible, and with a wire having a reasonably large surface area and low internal resistance. It is one of the properties of this coil that enables us to have

How It Operates

The fundamental importance of oscillators in many basic circuits makes a thorough understanding of their operation a must for all radio-electronic workers.

F. SCOTT

simple oscillators. When an electric current is passed through the wire a magnetic field is set up around the wire. This field manifests itself in the form of invisible lines of force that have magnetic properties. As the current through the coil is increased, these lines of force radiate farther from the coil and as long as the current is increasing the lines are in motion moving outward from the coil. One of the characteristics of this moving magnetic field is that it will cause an electric current to be set up in any conductor that it crosses. This induced current is in the opposite direction from the current flowing through the coil.

Since there is a magnetic field around each of the turns, and since the turns are close together, the magnetic field about each turn will cut or embrace other turns in the coil. When the current is increasing—the field expanding and moving across the turns—a current in the opposite direction from the initial current will be induced in the coil. These currents, being in opposite directions, oppose each other and the net current will be the algebraic sum of two.

Summing this up, we can see that any increase in the current through a coil will be opposed by one flowing in the opposite direction. This action takes place only when there is a change in the strength of the current in the coil.

Conversely; if the current through a coil is decreased or shut off entirely, the magnetic lines of force will tend to move back toward the conductor. As this field is collapsing toward the coil, it cuts the turns of the coil and induces a current in them that is in the opposite direction and has a tendency to cause the current to remain at its previously high level.

From this we can see that any change in the current through coil will be opposed by an *induced current* in the opposite direction, in accordance with Lenz' Law.

WHY IT OSCILLATES

In our simple oscillating circuit, we have a charged condenser, an inductor and a switch. When the switch is closed, the electrons try to rush from the negative plate to the positive through the coil. As the electrons pass through the coil, a magnetic field is set up around it. When the supply of electrons on the two plates is about equal, the current will decrease toward zero; thereby causing the magnetic field to collapse toward the coil. This collapsing field will induce a current in the coil that will cause an excess number of electrons to flow to the other side of the condenser. When the field has completely collapsed, the excess electrons will rush back to the other plate, thereby setting up a new magnetic field around the coil. This process would continue indefinitely if it were not for the fact that some of the electronic energy is dissipated in overcoming the direct current resistance of the conductor.

In order to have sustained oscillations, the electrons that are lost in the overcoming of the resistance of the coil must

be replaced as soon as they are lost. If we were to find some method of charging the condenser at the termination of each cycle or oscillation, sustained oscillations would result.

A vacuum tube is the only practical method for applying the charging voltage at the proper instant, since this operation must be performed many times—sometimes many million times—per second. The number of charging pulses per second will depend upon the relationship between the capacity of the condenser and the inductance of the coil. Experiment has shown that when $L =$ inductance (in henries) and $C =$ capacitance (in farads), the frequency in cycles (F) may be found from the formula

$$F = \frac{1}{2\pi \sqrt{LC}}$$

By inserting our simple oscillating circuit (L, C) between the grid and cathode of a vacuum tube and placing a small coil, L_2 in the magnetic field of the grid coil, and connecting this coil between the plate and a positive voltage, we have a simple oscillatory circuit that is capable of sustained oscillations.

Our oscillator has now become a vital part of a very elementary circuit that is the basis for oscillating circuits in many receivers and transmitters. The basic circuit is credited to Armstrong and has since undergone minor changes to improve its performance.

Fig. 4 shows this circuit in one of its simplest forms. To set the circuit in operation, the filament is turned on and when operating temperature has been reached, the plate voltage should be applied. A current then starts to flow through L_2 and sets up a magnetic field that expands with the increasing current. This expanding field induces a voltage in the grid coil L_1 , which is applied to the grid of the tube and to the condenser, C .

If the induced voltage in L_1 is in such a direction as to make the grid positive, the plate current will continue to increase until it reaches its maximum or saturation point. The plate current will remain constant at its maximum. Since the current through L_2 is constant and unchanging, a voltage will no longer be induced in L_1 .

With the charging voltage removed from C , its charge of electrons from the negative plate will flow through L_1 in such a direction as to make the grid less positive. This change in the grid voltage will cause a plate current which will lead to the collapse of the magnetic field about L_2 . This will cause a current to be induced in L_1 in a direction that will tend to make the grid still less positive. The action will continue until the grid becomes sufficiently negative to cause the plate current to reach a low, but constant value.

Condenser C will now begin to discharge through L , and this current will be in such a direction as to make the grid less negative. This change in grid voltage will cause the plate current to flow again and the en-

(Continued on page 180)

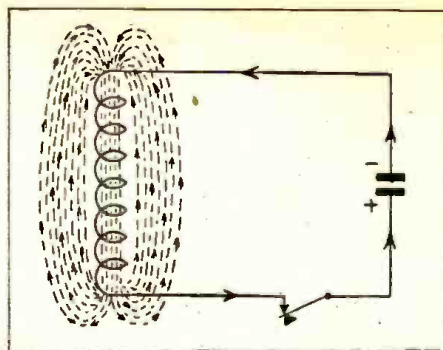

Fig. 3—The simplest type of oscillating circuit.

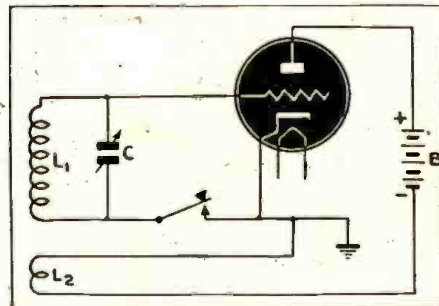

Fig. 4—The tube permits sustained oscillations.

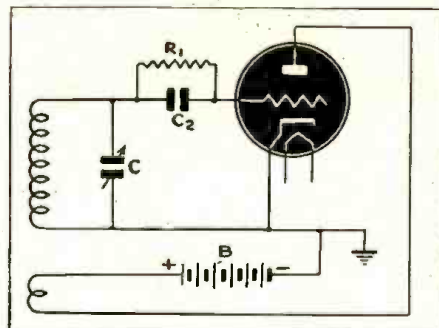

Fig. 5—An improvement on the oscillator of Fig. 4. Grid leak and condenser provide bias.

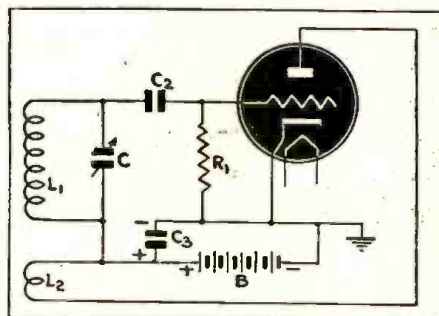

Fig. 5-a—The grid leak may go from grid to cathode, sometimes with an R.F. choke in series.

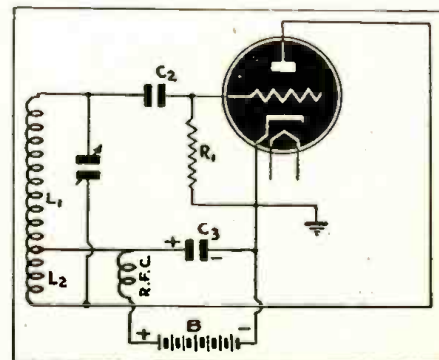

Fig. 6—The Hartley oscillator, a famous circuit.



U. S. Army Air Force Photos

Lower left.—Tubes are being checked and a dynamotor cleaned by these mechanics. Upper left.—Instruction on duties in the Base Operations Section. Center.—Policing aerial traffic from the control tower. Upper right.—Learning code is always an important part of the student radioist's work. Lower right.—Attractive trainee testing tubes on a BT-13A receiver.



WACS and Defense

WACS now fill an important place in the army's job of establishing and maintaining communications. They work as telegraph and teletype operators, on telephone switchboards, and in telephone and telegraph repair. The Signal Corps has its own training program for WAC radio operators, and they work as radio mechanics and code instructors as well as operators.

The Signal Corps School has two regular courses, one for prospective radio operators, and a second for radio repairmen. The course is slightly different from what the old-time civilian radioman would expect. Modern methods and the special requirements of the army are the reason. The new student starts with voice code, goes on to letter printing, instructions in sending and touch typing. Next she starts actual sending with a hand key at first, then a bug, and later copying code by pencil and on the mill. Finally net procedure theory and operation are studied, as well as blinker and phone procedure.

Prospective radio operators have to pass a general intelligence and aptitude test closely approximating that required for officer training, as well as make high marks in the special ROA (radio operator aptitude) test. They are also required to be able to type thirty words per minute before enrolling. Experience in International Morse Code is accepted in lieu of high standing in the aptitude tests.

The operators' course takes up twenty weeks. The course for radio repairmen is a shorter and more intensive one, occupying 13 weeks. The prerequisites for this course are even higher than for the operators' course. Experience in radio repair work or high-school education is required for entrance in this type of training. Three grades of repairmen are graduated: Radio Repairman, Fixed Station Repairman, and Radio Operator and Mechanic.

Once graduated as operator or mechanic, the new WAC radioman moves in to take

the place of former male operators at communications centers, air fields and army bases.

One of the first departments to release its male personnel for active duty, the Signal Corps at Stockton Field, Calif., now is entirely operated by the WACs, all of whom not only know their business but fully realize the importance of their jobs.

Charged with the responsibility of maintaining communications with the rest of the world, the Signal Corps at Stockton Field is the unit which keeps the steady flow of messages, both official and personal, moving across the wires from Lodi to India. Their nimble fingers and competent voices are the forces that bring reassurance to worried families and instructions for the prosecution of the war. Here WACs operate the telegraph, teletype, and telephone switchboard, and are panel and code operators. They are also trained as telephone and telegraph repairmen.

At Aberdeen Proving Grounds, Md., where the largest Ballistics Research Laboratory in the world is located, a detachment of WACs from all over the country are rapidly proving themselves capable of handling a multitude of jobs formerly thought impossible for members of the weaker sex. Almost 500 strong, and growing in number every day, their jobs range from clerical work to the exciting and challenging problems which confront Ordnance workers in this vast establishment.

At the Ballistics Research Laboratory, about one-half of the WACs at Aberdeen

are employed in extremely technical and responsible work. Women here actually build, maintain and repair radio equipment, both for sending and receiving, as well as the famous Edgerton Lamp equipment.

The WACs work at the well-known "differential analyzer," which figures complicated mathematical problems in a period of hours over which a staff of trained mathematicians used to labor for weeks. Others are employed in computing velocities at Chronographs and other similar instruments, both the portable and stationary laboratory types.

In the Army Air Forces Training Command, WACs are also employed in large numbers. Over 100 are employed at Sioux Falls AAF Technical School in South Dakota and another hundred at Truax Field, Madison, Wis. Other WAC detachments are to be found at AAF bases all over the country.

Beginning in September, radio training for the WACs was put directly in the hands of the Signal Corps, and the former schools, at which the trainees studied when the WACs were not an integral part of the Army, were discontinued. Further training will take place in existing Signal Corps schools at replacement training centers and actually on the job.

Many intelligent young women have taken advantage of the training program offered by the WAC radio courses, attracted not only by the opportunity to serve their country effectively in a time of emergency, but also by the prospect of developing skills which will fit them for after-war positions in the radio field. The recent extension of the age limits for recruits resulted in bringing in a new group, who are still enlisting. New operators and technicians are being and will continue to be trained until the objective of releasing every possible man for active combat duty, by replacing him with an equally competent WAC, is attained.



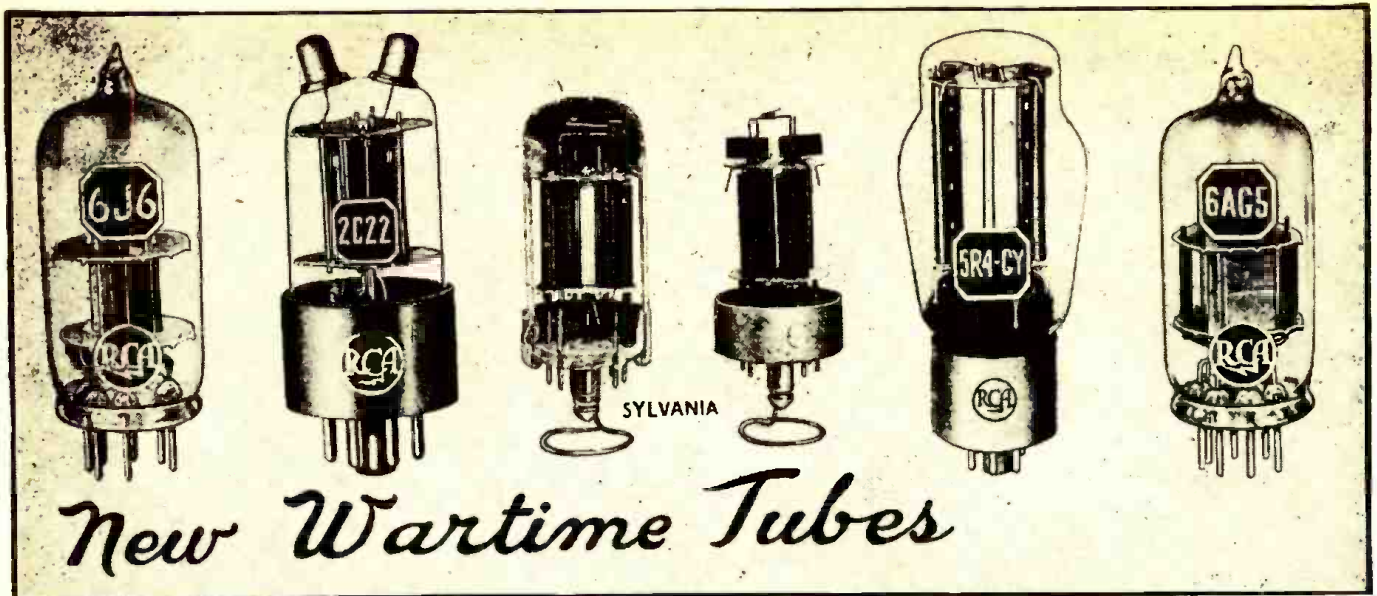

THE war, directly responsible for a drastic reduction in the number of electron tube types manufactured, is now behind the development of a number of new ones. Seven new tubes have been announced by RCA—all for applications directly connected with wartime developments.

A 28-volt tube put out by Sylvania has some radically new features. Built to operate in airplane receivers, this power output pentode operates with the same 28-volt supply for filament and plate. It therefore works direct off the plane's 28-volt system, and requires no batteries, vibrator or other device to furnish high voltage for the plates.

28 VOLTS FOR "A" AND "B"

The new tube—known as the 28D7, and shown in cut-away at the top center of the page—consists of two beam power units in the same bulb. The two cathodes are brought out to a common terminal, as are the two screen grids. The two units can be used as independent amplifiers, paralleled to form a single tube, or used in push-pull.

The two sections of the tube may be operated separately, they may be connected in parallel, or they may be employed in a push-pull circuit. Two different recommended loads per section are specified, the choice depending on whether both sections are to function as single-ended amplifiers or whether the two sections are to operate in push-pull. Where each section is used as a single-ended amplifier, the load per section should be 4000 ohms, to insure reasonably low second and third harmonics. If the two sections operate in parallel, the load would be approximately half this value. For push-pull operation, the load per section should be 3000 ohms since with this value the third harmonic is low and the second harmonic, although high, will cancel due to the push-pull circuit. A plate-to-plate load of 6000 ohms should be employed.

In general, self bias will probably be employed and under such conditions power outputs exceeding 150 milliwatts can readily be obtained from a single tube operating in push-pull from a resistance coupled driver. If a separate bias voltage supply can be provided, fixed bias operation will furnish additional power output since it permits utilization of the total supply voltage. An increase in effective B voltage of about 3.5 volts is an important factor at low voltage operation. In some applications bias voltage may be obtained from an oscillator, thus making it unnecessary to provide a separate battery for grid bias and also per-

mitting the use of the total plate supply voltage. The d-c resistance of the output transformer plate winding should be as low as possible to minimize the voltage drop to the plates.

VOLTAGE LOW—POWER HIGH

Type 28D7 is designed to furnish comparatively large amounts of power at low plate voltages. The cathode power is proportionately higher than usually used in power output tubes. The precautions customarily recommended for satisfactory performance of output stages are particularly important with Type 28D7 tubes. In resistance coupled applications the grid resistor should not exceed 0.5 megohm per grid under self-bias conditions and 0.2 megohm per grid for fixed-bias conditions, to minimize the effects of grid current. A low- μ driver tube having an amplification factor of 20 or less is more satisfactory for driving the Type 28D7 tube to maximum output at low distortion.

Power output of the order of 600 milliwatts is possible from a single Type 28D7 under Class A2 conditions at approximately 11% distortion. Another Type 28D7 is capable of furnishing the driver power with an interstage transformer having an impedance ratio of 6:1 (primary to $\frac{1}{2}$ secondary).

The power output of a Type 28D7 is very flat over a wide range of heater voltage. There is a drop in power output of approximately 3% with a heater voltage change from 32 volts to 17.5 volts.

In applications where the tube is required to operate for any extended period at heater voltages in excess of 28 volts, a resistor should be inserted in series with the heater supply voltage and the heater.

STANDARD TUBES AT 28-V

Co-incident with the release of the 28D7, experiments were made to determine the action of standard receiving tubes with 28-volt plate supplies. Several tubes were selected to use in a 28-volt receiver. Among these were the 14J7, a triode heptode whose frequency stability characteristics render it especially suitable where oscillator amplitude and frequency shifts might be expected with other types.

The type 14H7, which has a mutual conductance of 3800 micromhos with 250 volts on the plate, shows a mutual of 2800 with the 28-volt supply. This performance is more favorable than that obtained with most other pentodes having either higher or lower mutual under rated conditions.

Type 14R7, which has a mutual conductance of 3200 micromhos under 250 volt operating conditions, shows a mutual of 1500 with 28 volt plate supply. This performance is better than that obtainable with any other diode pentode tube which is regularly available. When triodes are used to drive the grid of the Type 28D7 for 28 volt operation low μ rather than high μ types are more useful since the grid of the Type 28D7 may be driven to grid current and requires some power. The Type 14E6 is recommended when a diode triode is needed, while Type 14N7 is most useful when a double triode is necessary.

NEW HIGH-FREQUENCY TUBES

The RCA tubes were developed for use on extremely high frequencies, or for use in the light portable military receivers. A new high-vacuum rectifier, with a peak inverse voltage rating of 2400 at 250 Ma. output is also announced.

One of the most interesting of the new tubes is the 2C22, a miniature-base triode with two top caps. It is designed for special high-frequency applications, including transmitter service. Capacities are extremely low, and the approximate resonant frequency of the grid-cathode circuit is 335 Mc.

The 6AG5 is another miniature tube, with the 7-pin button base, and is a sharp cut-off R.F. pentode amplifier for use in compact, light-weight equipment. It may also be used as a high-frequency intermediate amplifier.

Another miniature button-base tube is the 6J6 (a twin-triode amplifier) designed for either push-pull or parallel operation up to 600 megacycles. It may also be used as an oscillator, and with push-pull grid circuit and the plates in parallel, makes a good mixer up to the 600-Mc. limit.

The 6AK6 is a miniature power amplifier pentode for use either singly or in push-pull in the output stage of light-weight equipment. It resembles closely the larger 6C6-G in its electrical characteristics.

A detector tube, the 9006, completes the miniature series. The 9006 is a diode suitable for use as a rectifier, detector or measuring device in ultra-high-frequency circuits. Its resonant frequency is in the order of 700 megacycles.

Leaving the miniature types, we have the 12L8-GT, a multi-unit tube containing two power-amplifier pentodes with a common cathode. It is designed to work in the output stage of compact, light-weight equipment where moderate power is desired. It

(Continued on page 176)

TRANSMITTERS

By JULES M.

PART

Pure frequency modulation theory is modified to some extent in practice, so that other advantages, such as frequency stability and simplicity of apparatus, may be realized. These considerations are discussed here.

In the last installment we discussed the reactance method of shifting the transmitter oscillator frequency in accordance with the amplitude of the audio modulating power. To accomplish this an oscillator of the self-excited variety has to be employed. Such an oscillator naturally gives rise to an inherent frequency instability, so common in self-excited oscillators. The reactance method is finding widespread use in portable and mobile installations where flexibility is the keynote, but where absolute frequency stability is imperative this method does not meet the standards.

The most stable oscillator is of course the crystal type; however, the incremental inductance and capacitance possessed by a crystal is so small that it is impractical to employ the reactance method of modulation with it. This brings us to the method universally employed by FM broadcast stations.

It will be of some benefit to the reader to differentiate between the two methods of obtaining FM. In the reactance method of modulation the oscillator frequency deviation is proportional to the amplitude of the audio modulating power; whereas, in the phase method of modulation the frequency deviation is proportional to both the amplitude and frequency of audio modulating

power and this factor must be compensated for to obtain the same results as obtained by the reactance method. Phase modulation may be defined: A shifting of phase of the side band currents of amplitude modulation with respect to the carrier.

In phase modulation the phase deviation is proportional to both the amplitude and frequency of the audio-power. For example, if an audio power of 2 watts and a frequency of 1000 cps. produced a 10 kc. deviation of the carrier frequency, then an audio power of 2 watts and a frequency of 2000 cps. would produce a 20 kc. deviation. In order to compensate for this factor frequency attenuating networks must be employed in the audio section of

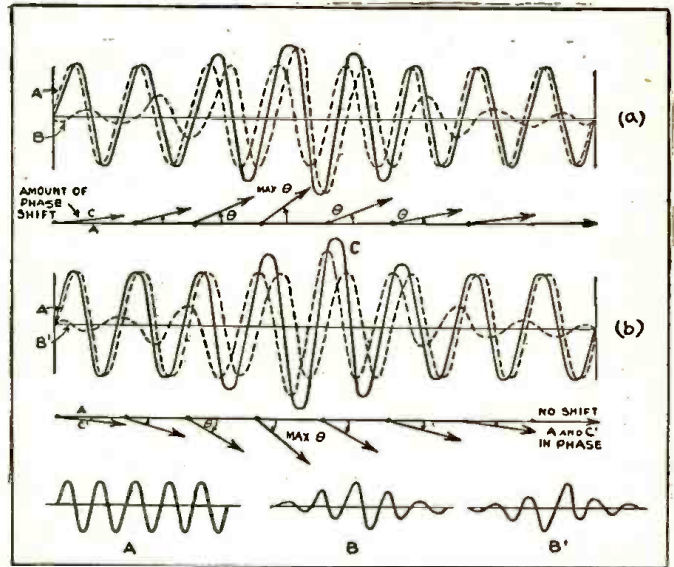

Fig. 2—Effect of two out-of-phase components in the mixer output tank.

the system. If the transmitter is designed to translate the low audio frequencies, such as are used for communication work, then an attenuating network is employed to reduce the amplitude of higher audio frequencies relative to the lower audio frequencies. This system is called an *integrator*. In the case of broadcast work the opposite is usually the case and the network used is called a *differentiator*. In order that the output of the system be frequency modulated one of these networks must be employed, otherwise the output would be amplitude modulated with its relative phase angle changing. This will be understood more clearly as the theory behind the phase method progresses. The first two circuits we will consider illustrate these different points.

In Fig. 1 is shown one of the basic phase modulation crystal systems. It consists of a conventional crystal controlled oscillator, a balanced modulator, and a mixer circuit. The oscillator plate circuit is tuned by T1 and the output is coupled to the oscillator grids of pentagrid balanced modulators through blocking condensers C1 and C2 respectively. The oscillator output is also fed through a phase splitting network C and R to the grid of the mixer which operates as a class "C" amplifier with grid leak bias. In the phase splitting network C and R; the reactance of C is made very low at the operating frequency (about 100 $\mu\text{fd.}$), and R is made extremely large with respect to the reactance of C, so that

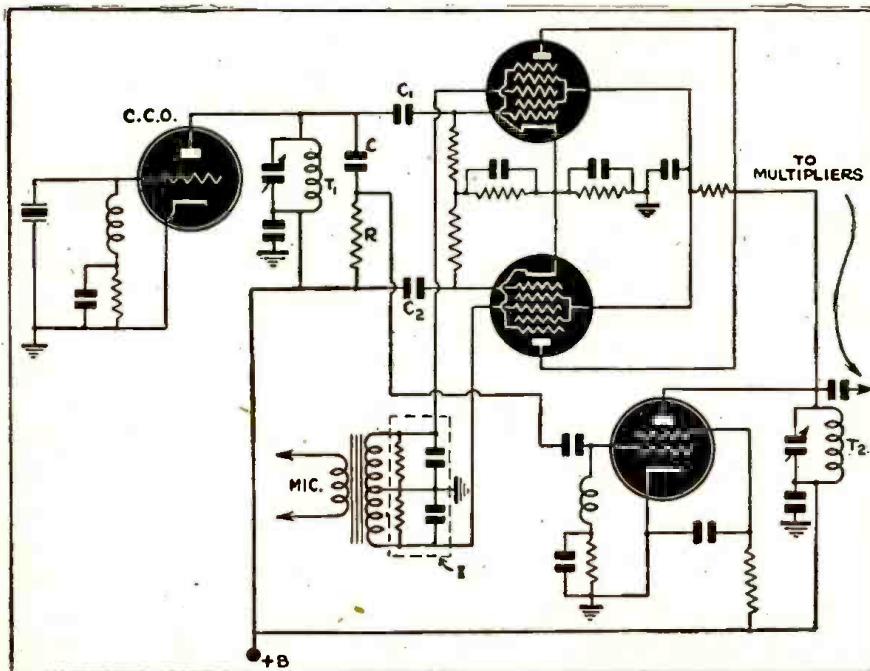

Fig. 1—Schematic of a more or less conventional type of frequency modulation circuit.

FOR FM

KLEINMAN

II

the R-F current and voltage in T1 are essentially in phase. The R-F current flowing through C, leads the R-F voltage across C being in phase with the oscillator tank voltage. The current flowing through C also flows through R; the voltage drop across R will be in phase with the current flowing through it, since the current flowing through R is leading the tank voltage by 90° then the resultant voltage drop across R will also lead the oscillator tank voltage by 90° and this leading R-F voltage excites the mixer grid.

The oscillator output fed to the balanced modulators' oscillator grids is taken off opposite ends of the oscillator tank T1; therefore the oscillator grids of the balanced modulators are excited 180° out of phase, constituting the R-F injection into the audio system. These grids are operated in the vicinity of class "C," making the tubes essentially class "C" R-F amplifiers.

Audio voltage from the microphone is fed through the integrator network I, which consists of large R and large shunt C to reduce the amplitude of the higher audio frequencies to prevent excessive deviation. The audio voltage, which has now been frequency corrected, is fed to the control grids of the balanced modulators. These grids are cathode biased and comprise the audio section of the system. The grids are also excited 180° out of phase so that, when the modulation is progressing the plate currents of V1 and V2 will be 180° out of phase. It can be seen on the diagram that the modulator plates are connected in parallel; therefore, the amplitude modulated carrier plate currents will continuously cancel giving rise to the side band currents which will be in phase with the R-F carrier voltage derived from the oscillator output.

Let us now analyze what takes place when a modulating signal is applied. The A-F signal which is fed to the control grids of V1 and V2 will alternately make those grids more and less negative respectively, since the current flowing in the plate circuit will be an R-F plate current proportional to the R-F excitation on the os-

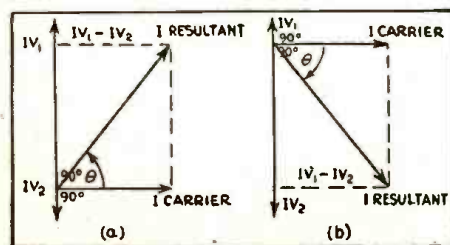

Fig. 3—The Fig. 2 effect shown by vectors.

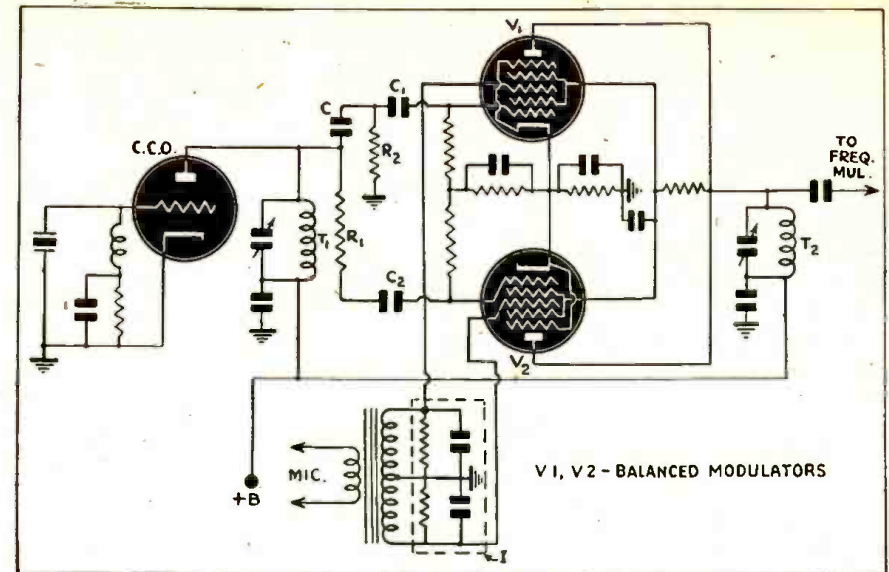

Fig. 4—This simplification of the conventional FM circuit dispenses with the mixer tube of Fig. 1.

cillator grids and the audio voltage changes on the control grids; will determine the magnitude of the R-F plate current.

The output of V1 and V2 is fed to the plate tank circuit of the mixer T2 which is tuned to the oscillator frequency. The mixer grid is excited by the R-F carrier developed across the phase splitting network, so that the R-F plate current which is the side band current of amplitude modulation are 90° out of phase with the R-F voltage impressed on the mixer grid. Therefore there are two components existing in the mixer tank T2; the R-F carrier current and the side band current from the balanced modulators which are at phase quadrature. This is seen more clearly in Fig. 2. Here we are assuming the voltage on V1 is becoming less negative; therefore the R-F plate current of V1 is increasing and of V2 is decreasing.

Adding side band currents B and the R-F carrier current A vectorially 90° out of phase gives the resultant frequency modulated wave C. Actually wave C leads the carrier by some phase angle, depending upon the instantaneous side band current amplitude; the greater the amplitude, the greater the phase shift and the frequency shift. The maximum phase shift obtainable is 90°. With the integrator network the frequency deviation will be proportional to the amplitude of the audio only.

It can also be seen that the resultant is amplitude modulated also, but the following class "C" stages of the transmitter will iron out these variations. When the grid of V2 becomes less negative and V1 more negative the converse will be true and the resultant wave C will lag the carrier at any angle between 0 and 90°. Vectorially we have depicted both cases in Fig. 3. It should be remembered that the R-F carrier current output of the mixer and the amplitude modulated R-F output of V1 and V2 are always 90° out of phase and the outputs of V1 and V2 are 180° out of phase with each other.

The crystal oscillator is usually operated at a low frequency for good stability and the mixer output is then fed through the desired number of frequency multiplier stages to raise the carrier frequency to the proper channel. In raising the carrier frequency by frequency multiplication, the frequency shift is also raised proportionally to the final value. If the maximum frequency deviation obtainable is to be 75 kc. and two quadruplers and a doubler are used the fre-

quency shift at the carrier frequency need be only 75/32 or 2344 cps. This indicates that very little audio power is required to give the maximum frequency shift necessary. This system provides one of the simplest and most stable methods of obtaining frequency modulation at present.

A modification of this system has been devised, but the process employed is still unchanged. From Fig. 4 it is evident that the only change which has been made is the removal of the mixer stage. This simplifies the arrangement from an economic point of view, and the operating efficiency is unchanged as compared to the method of Fig. 1. In this system you will notice that the output of the C.C.O. is fed directly through a phase splitting network C, R1, and R2 to the injection grids of the balanced modulators.

The operation of the phase splitting network is somewhat different for the simple reason that, as the injection grids are fed directly with a phase shift, equal excitation must still be present on the grids. From the diagram it is seen that the R-F current from the oscillator tank is fed through C and R1 respectively to the injection grids of the balanced modulators. Since T1 is a resonant circuit the R-F voltage and current are in phase at this point; however, the R-F tank current flowing through C leads the R-F tank voltage by 90°; this same leading current flows through R2, and since the voltage drop across R2 will be in phase with the current flowing through it, the R-F voltage across R2 will lead the oscillator tank voltage by 90°. On the injection grid of V1 we then have an R-F voltage which leads the oscillator tank voltage by 90°. The R-F tank current also flows through R1 to the injection grid of V2, and the voltage drop across R1 will be in phase with the tank voltage, because the tank current is in phase with the tank voltage.

The resistance values of R1 and R2 are made equal (usually 5000 ohms) so that equal excitation is applied to V1, and V2 for proper balance. The reactance of C, C1 and C2 are all low at the operating frequency to minimize the voltage drop across them. C1 and C2 are of equal value, so that the phase shift across each will be equal and opposite, providing a cancelling effect.

Concluding, the R-F voltages on the injection grids of the balanced modulators are equal in magnitude and 90° out of phase. (Continued on page 172)

How to Service

By FRED

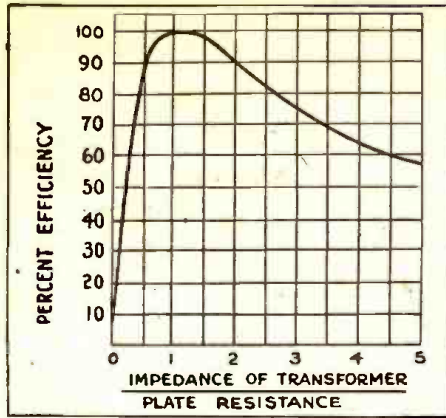

Fig. 1—How the power transfer efficiency of the triode output tube varies with transformer impedance, falling slowly from the maximum.

It has long been the practice of efficient radiomen to *replace* defective loud-speakers. A quick job is assured and a permanent repair guaranteed. Conditions are not quite so simple today, and it is not always possible to get the correct speaker for replacement. Thus the question of speaker repair arises, together with that of using the large number of damaged units now gathering dust on the shelves of the shop junk-room.

The loud-speaker consists of three main parts; field, output transformer and cone

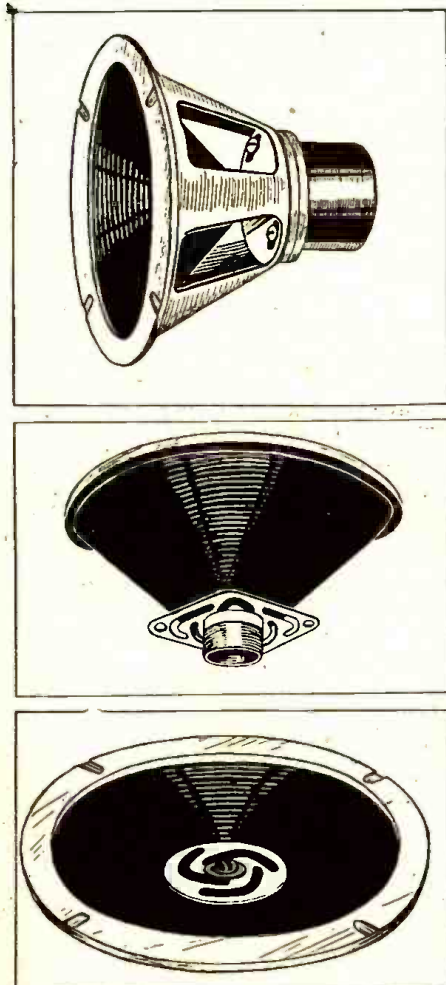

Fig. 2—The cone may be centered by (top) an adjustable frame, (middle) an external spider, or (bottom) a spider centered on the magnet core. Small types may be non-adjustable.

assembly, each with its characteristic defects. Of these three, the output transformer is the most prolific source of trouble. It invariably goes bad because of a burned-out primary.

The output transformer may be rewound. The technique has been described in past issues of *Radio-Craft*. The job usually takes too much time to make it worth while on any but the most expensive jobs. It may also be replaced with a new one of similar characteristics. If no new one is available, it is in order to look around and see what use may be made of units on hand, now attached to speakers discarded because of broken cones or burned-out fields.

Three conditions must be met: The transformer must be big enough to carry the currents required, without excessive voltage drop or magnet saturation; the primary impedance must be suited to the output impedance of the tube or tubes which will feed into it; and the secondary must have the correct number of turns to match the impedance of the voice coil on the speaker with which it is to be used.

A SUITABLE REPLACEMENT

If we require an output transformer to work between a pair of push-pull 45's and a 40-ohm voice coil, the first thing to do would be to look for a transformer which was used in an exactly similar circuit. Assume however, that we have no such transformer, but have one that was used between a pair of 6L6's and a 4-ohm voice coil. Can it be used?

From the tube manual, we find that the primary impedance of a transformer used with push-pull 45's is likely to lie between 3,000 and 5,000 ohms. The same source—or a transformer catalog—shows that output transformers used with 6L6's are likely to have an impedance varying from a little over 3,000 ohms to more than 6,000. Obviously the impedance is not likely to be too low for the triode amplifier, and as the efficiency of an output transformer in a triode circuit drops off rather slowly as its impedance is increased above the optimum value (see Fig. 1), you will never notice if it is too high.

Let us look at the opposite picture. We need a transformer to work out a pair of 6L6's and have one from a set using push-pull 45's. Will it be useful?

First of all, we note that the set was an old low-voltage type, and that the transformer impedance would therefore be very near the lower 3,000-ohm limit, if not actually below it. Since 6L6's invariably work into impedances somewhat higher than this, the impedance is apparently too low. Add that the circuit may have been designed for a considerably higher impedance—up to 6,000 ohms or so—and that too low an output transformer impedance has an immediate and noticeable effect on the quality of reproduction, and we have to abandon the idea of using the transformer.

We now turn to a transformer originally used for a pair of 6F6's. The output impedance of most 6F6 circuits is in the or-

der of 7,000 ohms, so this might appear to be a prospect. At first glance, however, we see that the transformer is only half as big as the one it is to replace. Voltage drops across it would probably be too great; our signal current would use up too much energy heating the transformer and too little moving the voice coil. Distortion would be high and efficiency low.

REWINDING SECONDARIES

If you have a transformer with a primary winding suited to the job on hand, but the wrong secondary winding, it is a simple matter to take off the old secondary—which is invariably on the outside—and rewind it. Suppose you have a transformer which has worked into a 2-ohm voice coil. You want to use it on a speaker whose voice coil has a resistance of 4 ohms. Unwinding the secondary, you find it has 50 turns. How many turns do we need for an impedance of 4 ohms?

We know that the impedance ratio of a transformer increases with the square of the turns ratio—that the impedance is proportional to the square of the number of turns. So all we have to do is square our 50 (2500), double that (5,000), and take the square root (71 approximately). Our new secondary should have 71 turns.

(Incidentally, this suggests a method by which we might find the impedance of a primary. Knowing the secondary impedance [by direct measurement of the resistance of the voice coil to which it is attached], we can put the primary across the 115-volt line, and measure the secondary voltage. This will give us the approximate turns ratio, which is the square root of the impedance ratio.)

Our new 4-ohm winding will have higher voltages and lower currents for the same power, so we can use finer wire in winding it. Thus the 71 turns can be put into the same space as the former 50.

THE SPEAKER CONE

Cones give the radioman more trouble and exacting work than any other part of the speaker. Some of this is avoidable. Many of the tears and cracks in speaker cones are the result of accidents in removing them from sets, or during transportation and even while on the service bench. A little care in this connection will save much labor.

The speaker cone is made of a heavy paper, and is either cemented direct to the frame around its outside edge, or—in the higher grade speakers—fastened to strips of bookbinders leather which in their turn are fastened to the frame. A cylindrical voice-coil former is attached to the center of the cone. This may be of paper or thin bakelite.

On all but the smallest speakers, some means of centering the cone in the gap around the center pole-piece is provided. See Fig. 2. On the largest speakers, the whole frame on which the cone is mounted is bolted to the assembly, with the holes through which the bolts pass slightly over-

Radio Speakers

SHUNAMAN

size. Thus with the bolts loosened, the cone can be centered, then tightened into position. In many cases there is a spider in the center of the cone, which is fastened to the center pole-piece with a machine-screw. Other speakers have the spider underneath the cone, also fastened with a pair of screws in such a way as to make centering possible.

Tears and cracks are a common trouble. The remedy is too well known to many repairmen, and many a set has come into the shop with stiff, heavy paper patches on the cone. Both the sensitivity of the speaker and quality of reproduction must suffer as a result.

The right way to repair a small crack is to take well-thinned cement and a small brush, and work a little of it in along each side of the crack. In most cases a patch will not be necessary, as the edges of the crack, re-inforced by the cement, will remain firmly together. As little extra stiffness and weight is added to the cone as is consistent with doing a good repair job. Jagged broken tears must of course be patched, thin paper being used.

Another common cone trouble is the open voice coil. This is readily located by the absence of "speaker hum" though voltages on the output stage are normal and the output transformer primary is in good condition. The open is usually due to a poor connection between the wire of the voice coil and the flexible strip which connects it to the output transformer. It can be found by removing the piece of paper usually cemented over it, and re-soldered. This is an easy repair job. It is usually due to a hurried soldering job on the original connection, or to the use of soldering paste.

Sounds resembling those caused by a cracked cone may often be traced to a loose voice coil—one not properly cemented to the cone. Some old Majestics were especially bad offenders in this connection. The remedy is to cement and let the assembly dry for a day before putting signals through it. A cone loose along the edge will make itself known with characteristic sounds, and simple cementing is all that is needed to put it into good condition.

CENTERING THE CONE

The off-center voice coil is more troublesome. The symptom of this trouble—high-pitched scratching sounds—is well known to every radioman. It can be readily verified by pushing the cone in and out with the two thumbs, holding the ear close. The scraping of the cone on the pole-pieces can easily be heard. (Fig. 3.)

If this scraping has continued long, the insulation may be worn off the wire over part of the voice coil. In such cases all dust and metal fragments should be brushed off, and a layer of thin cement applied to the spot, to prevent possible short-circuits.

The cone should now be centered. Loosen the screws which hold the cone in center position, insert three or four shims between the voice-coil form and the center-pole-piece, as shown in Fig. 4, and when you are certain that the cone is exactly

centered, tighten the screw or screws again, remove the shims, and check for scraping. Shims of different thicknesses may be cut from old photo film, heavier sheet celluloid or thin electrical fiber. Metal shims are not recommended, as they can scrape or cut the paper form in which they are inserted. The shims should be thick enough to fit snugly, but not tightly.

Some of the smaller midget cones have no provision for centering. These have to be released from the frame, centered as above, and recentered. The cone can be removed by applying laquer thinner or cement solvent to the rim, thereby softening the cement. Keep on going around with a brush till the cement is soft, then slip a thin knife blade between the frame and the cone. If it does not come away readily, continue applying solvent.

A sound like that of an off-center cone will often be caused by iron filings or other matter between the voice coil and the magnet. These can often be located by drawing the coil out as far as possible and examining the surface of the wire for scratches. Once discovered, the iron may be worked out with strips of stiff, slightly dampened paper. Some servicemen connect the field across the A.C. line while removing metal scraps, to destroy any magnetism which might cause the filings to adhere to the pole piece. It is claimed that in many cases the filings may then be knocked out with a few taps on the frame.

In a few cases the cone will be found distorted in shape, due to exposure to damp air, which causes it to sag. In some cases this may be helped by ironing it out with a hot flatiron. The voice-coil form may also get out of shape. The traditional method of straightening it out is to insert a round cork tightly and put it away over the week-end.

In the early days of the cone speaker, constructors used to buy their own paper and construct cones—sometimes more than a yard across. I have never attempted this, but there is no reason an attempt to replace a badly damaged cone should not be successful. The old cone—or what is left of it—could be used as a pattern for the new one.

THE FIELD ASSEMBLY

The field gives less trouble than any other part of the speaker. When trouble does occur, it is because of an open or shorted coil. Few repairmen have ever attempted to make repairs in such cases, though a speaker field is the easiest of all coils to rewind. If the wire is carefully run off onto a spool, meanwhile carefully watching for corroded "green spots," most of it will be found in good condition, and can be wound back on again.

A winding jig will be needed of course, and the job takes a certain amount of time, but the work is worth doing, especially on large and expensive speakers.

Should the corroded area be found near the center of the coil, close to the cardboard former, it may be assumed to be due to chemicals in the cardboard, and several

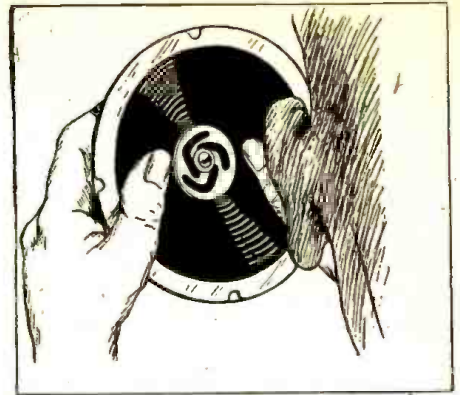

Fig. 3.—How to find a scraping voice coil.

layers of insulating varnish or coil cement should be applied to the form and let dry before rewinding.

In many cases field coils from speakers discarded for other defects, can be used. If the coil is of approximately the same physical size and resistance, it will work all right. This can be done to good effect in small speakers, where it is often possible to find the exact duplicate of the defective coil.

In some of the smaller speakers the dif-

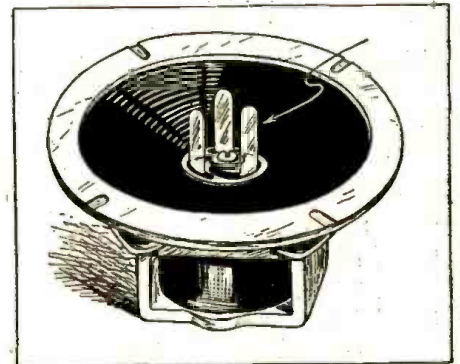

Fig. 4.—Shims in position for centering cone.

ficulty is to get the coil out. Large speakers almost invariably are made in three parts: a frame holding the cone; the top of the pot magnet, in the center of which is the hole for the voice coil; and the pot itself, with the center piece holding the field coil. Some of the smaller speakers are also bolted together, and the coil may be removed by taking out the bolts. Others are made with a one-piece frame, into which the pole-piece is set.

To get the coil out of one of these, re-
(Continued on page 182)

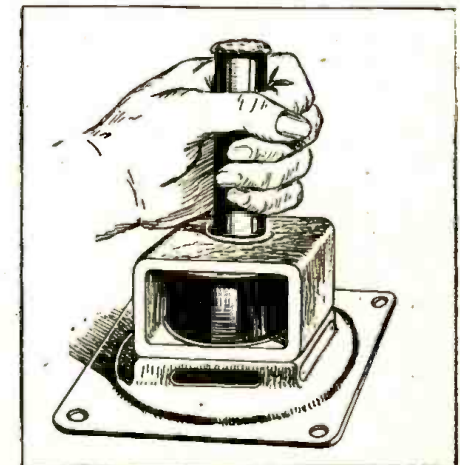
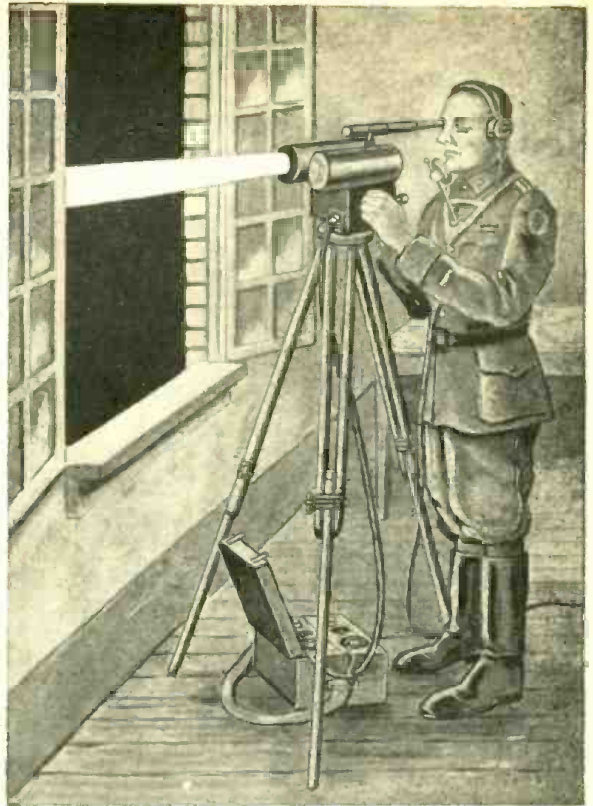

Fig. 5.—How to remove some speaker coils.

LIGHT-PHONE USED BY NAZIS



The artist's concept of the light-beam phone in use.

THE German Army has for some years had a practicable, fool-proof Speech-on-Light apparatus, which, in certain circumstances, replaces field telephone systems and U.H.F. field radio sets.*

The apparatus consists of a sender-receiver head, which resembles an over-size pair of binoculars. The head contains the lamp, the modulating device, the color filters, the transmitting lens, the receiving lens, the photo cell, and its amplifier. A built-in telescope is included, and the head stands on a tripod. The entire apparatus may be carried by one man.

An important feature of the instrument is that it may be operated on white, red, or infra-red light, merely by selecting the required filter with a knob. The use of infra-red light eliminates the possibility of interception, and insures secret communication in the dark; while the range is not appreciably reduced.

(Of course, for night operation, the instruments must either be lined up the previous day—or else at night, by showing a red light.)

The outgoing light is sharply focused to a parallel beam by means of an 80 mm. lens. The beam is six yards wide at a mile, and thirty yards wide at five miles.

The amplifier has a send-receive switch, hence duplex communication is not possible. However, provision is made for operation over a telephone line, and for this, the line

works into a bridge input circuit, which permits both send and receive amplifiers to operate simultaneously without instability.

The instruments must of course be set up in view of each other, and there must be no intervening objects. For this reason the stations should be elevated, assuring that passing vehicles, etc., do not interrupt the light beam path from transmitter to receiver.

Shimmering heat currents rising from the ground (so common in hot deserts) give rise to interference, but the circuits are designed to minimize this effect, as will be shown later.

The effective range of the apparatus depends largely on atmospheric conditions, but five miles is about the average. This range is considerably decreased in rain, and increased when the atmosphere is very clear. It was not tested in fog, but it is assumed that although the infra-red ray will to a large extent penetrate fog, the range must be greatly reduced.

Provision is made for keying the lamp filament by means of a push button. This provides for Morse transmission and therefore

greater ranges, but reception must be entirely visual.

For a number of years, experiments have been carried out on modulated light. There are two methods of applying voice modulation, first, by directly modulating the light source by the L.F. Signals, and second, by using a constant intensity source and modulating the outgoing beam. No great successes have been achieved by modulating the source. With filament-type lamps, the thermal inertia of the filament presents some difficulty, especially at high voice

(Continued on page 178)

*Earlier articles on photophones appeared in *Radio-Craft* in April, 1933, May and September, 1934, January, 1939 and May, 1942.

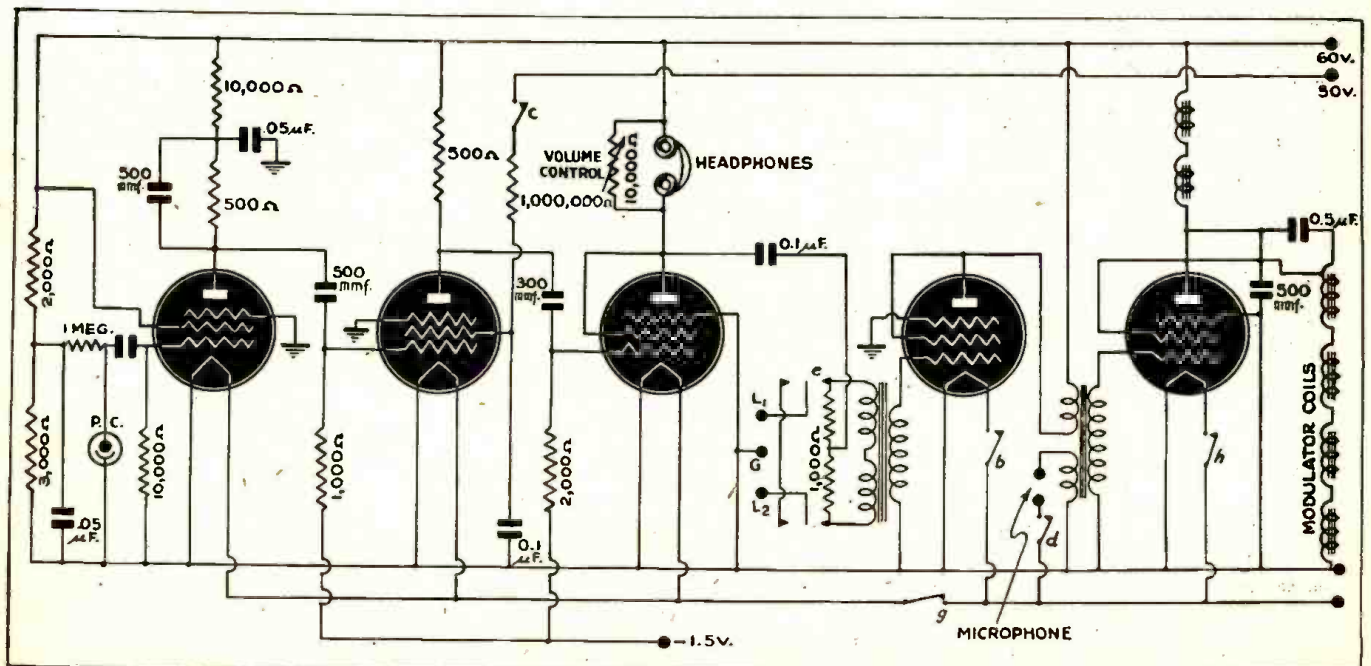
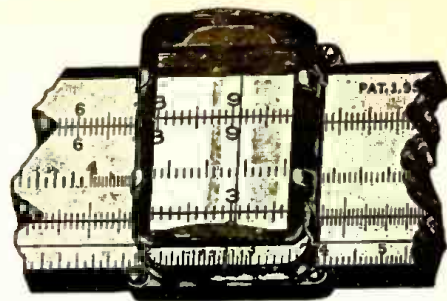
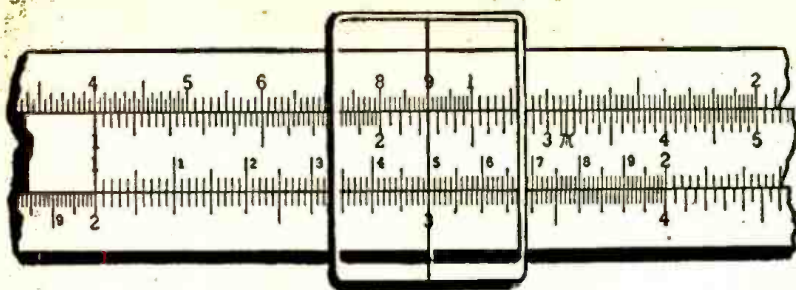

Fig. 1—Schematic of the apparatus. The first three tubes comprise the "Receive" amplifier. The last two are the "Send" amplifier.



The rule is now set up to multiply 2 by 1.5, to divide 3 by 1.5, or to obtain the square root of 9. A magnifier makes it easier to read accurately.

Radio and the Slide Rule

MANY of the mathematical problems arising in Radio Service work can be solved quickly, easily and accurately with the Slide Rule. Some service men have the mistaken idea that the slide rule is only for engineers, and that one must be thoroughly expert in mathematics to use it. It is really the other way around; problems involving square root can be solved on the rule faster than the problem may be written on paper, and no knowledge of the arithmetical method is needed at all!

Parallel resistors, series condensers, square and cube roots, transformer turns ratios, reciprocals, etc., can all be solved by the slide rule with more than enough accuracy for service work. Instead of a long, detailed exposition on slide rules in general an effort will be made here to present the fundamentals as applied to specific problems encountered by the service man. The theory of the slide rule has been set aside in favor of practical application. In most problems the values will be so familiar to Radio men that the placement of decimal points may be done by inspection, but the simple rules covering these things will be given.

THE RULE AND ITS SCALES

The ordinary slide rule having only four scales on the face is the least expensive and will serve our purpose just as well as the more expensive Polyphase instruments. The stock of the rule has two scales; the A scale across the top and the D scale across the extreme lower edge. Between these is the Slide which also has two scales; the B scale right under the A scale and the C scale just above the D scale. The A and B scales are duplicates of each other, as are the C and D scales.

It will be noticed that the C and D scales are numbered from 1 to 10, while the A and B are numbered to have just twice the range, having two decades. We need not go into why this is so but this arrangement makes it possible to read square roots directly. When you learn to read the rule correctly the square roots of the numbers on A may be found directly under them on D.

The first operation to learn is that of multiplication. This may be performed on either

By WILLIAM B. MILLER

the A and B, or on the C and D scales. As the latter are the ones usually used we will illustrate with them. The numbers 1 to 10 may be given any values, such as .01 to .1; 1 to 10; 10 to 100; 100 to 1000; etc., just so they are multiples or submultiples of 10. There are ten main divisions between each number which represents one tenth of whatever value is assumed for the main numbers on the scale.

To illustrate we will multiply 2 by 1.5.

Set the left index (the first 1), of scale C to the number 2 on scale D, next move the indicator until the hair line passes through the half way mark between 1 and 2 on scale C (this will be the 1.5 mark). Directly under the hair line will be found the answer on D (3). The hair line is used to line up numbers on one scale with numbers on another scale. It is also useful to mark a mid position in an operation requiring the slide to be moved twice in the same problem.

Suppose we had taken 20×15 instead, the setting would be the same with different values assigned to the scale, and the answer would be 300. Thus if we take the whole scale to represent 1 to 10 the separate figures are units of one; if we take the scale as 10 to 100 the figures are tens and the subdivisions are ones, and so on. So we may multiply any number by any other number. The scale may even represent .01 to .1 in which case the subdivisions will be equal to .001.

SETTING THE DECIMAL POINT

There are two simple rules, governing the placement of the decimal point in multiplication, that it will be helpful to remember.

RULE ONE:

WHEN THE SLIDE PROJECTS TO THE RIGHT, IN MULTIPLICATION, THE NUMBER OF PLACES TO THE LEFT OF THE DECIMAL POINT IN THE PRODUCT IS ONE LESS THAN THE SUM OF THE NUMBER OF PLACES TO THE LEFT OF THE DECIMAL POINT IN THE FACTORS.

The number of places to the left of the

decimal point is referred to—for convenience—as the characteristic. This sounds involved but the following examples will serve to explain it. Consider:

1.5×4 , equals 6. Here there is one digit (characteristic) to the left of the decimal point in each factor, so by the rule; 1 plus 1 equals 2 (the sum of the characteristics), and 2 minus 1 equals 1, which gives us 6 for the answer and not .6 or 60. The slide projected to the right in this example, as well as the ones following that deal with Rule One.

25×30 equals 750. Here there are two digits (characteristics) to the left of each factor, which gives us 2 plus 2 or 4 and 4 minus 1 equals 3, so our answer is 750 and not 7500 or 75.

We have also to consider such problems where the factors are all to the right of the decimal, as: $.03 \times .02$; and, $.3 \times .3$. To apply the Rule here we consider the numbers to the right of and next to the decimal point such as .1, .4, .7, etc., as having a characteristic of zero; those numbers with one cipher after the decimal, such as .02, .08, as having a minus 1 characteristic, two ciphers as a minus 2 characteristic, and so on. If we tabulate these we can see how the Rule is applied.

$1.3 \times .05$

1.3 has a plus characteristic of 1

.05 has a minus characteristic of 1

1 minus 1 is zero and the Rule says minus 1 from that, so our answer is .065.

$.2 \times .3$. Here we have two zero characteristics so the answer has a characteristic of 0 minus 1 and is .06.

$.002 \times .004$. Each factor has a minus 2 characteristic. 2 and 2 make 4 and 4 minus 1 equals a minus 5 so the answer will have 5 ciphers before the first significant figure. .000008.

Some problems require that the slide project to the left instead of the right and the rule for this is—

RULE TWO:

WHEN THE SLIDE PROJECTS TO THE LEFT IN MULTIPLICATION THE CHARACTERISTIC OF THE PRODUCT IS EQUAL TO THE SUM OF THE CHARACTERISTICS

(Continued on page 184)

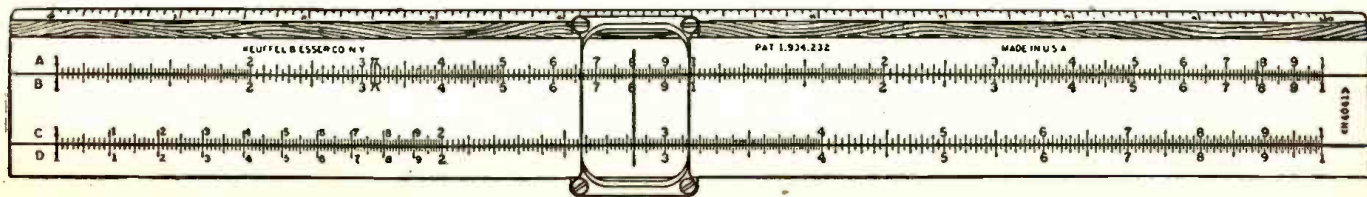



The Model 533 Combination.

BELMONT RADIO

RADIO-PHONOGRAPH MODEL 533

FREQUENCY RANGE 535 to 1690 KILOCYCLES

INTERMEDIATE FREQUENCY 465 Kc.

INSTALLING THE RADIO

Antenna: A capacity-type plate antenna is used on this radio. For reception of local or powerful near-by stations no other antenna is usually required. This antenna is not directional, however; noise or weak reception will result if radio is placed too near metal objects.

For best results at remote points from broadcast stations an outside antenna approximately 50 feet long including lead-in is recommended. It

should be erected as high as possible and as far from surrounding objects as practical. For minimum interference it should be at right angles to street car lines, incoming power lines and other electrical apparatus which may be in the vicinity. A ground is not required.

Connect the antenna to the antenna wire at rear of radio.

Power Supply: Caution: — This radio must be op-

erated from 105-125 volts A. C. 60 cycle supply only. If you are in doubt as to the voltage rating of the power supply, consult your local power company before inserting plug. Do not insert plug unless all tubes are in their proper sockets.

The power consumption of this receiver is 50 watts.

Hum: Reverse plug in receptacle (light socket) if receiver hums.

SERVICE DATA

TUBES:

The tube complement of this chassis consists of the following octal base glass and metal tubes.

The type and function of each tube is as follows:

- 1—Type 12SA7 Mixer, First Detector-oscillator.
- 1—Type 12SK7 I. F. Amplifier.
- 1—Type 12SQ7 Second Detector, A.V.C. and First Audio.
- 1—Type 50L6GT Beam Output Amplifier.
- 1—Type 35Z5GT Rectifier.

SERVICE NOTES:

Voltages taken from different points

of circuit to chassis are measured with volume control at minimum, all tubes in their sockets and speaker connected, with a volt meter having a resistance of 1000 ohms per volt.

All voltages as indicated on the voltage chart are measured with a 117 volt 60 cycle A.C. line.

Resistances of coil windings are indicated in ohms on the schematic circuit diagram.

To check for open by-pass condensers, shunt each condenser with another condenser of the same capacity and voltage rating, which is known to be good, until the defective unit is located.

Excessive hum, stuttering, low volume and a reduction in all D.C. voltages is usually caused by a shorted electrolytic condenser; open by-pass condensers frequently cause oscillation and distorted tone.

ALIGNING INSTRUCTIONS:

CAUTION:—No aligning adjustments should be attempted without first thoroughly checking over all other possible causes of trouble, such as poor installations, open or grounded antenna systems, low line voltage, defective tubes, condensers and resistors. In order to properly align this radio, the chassis should be removed from the cabinet.

ALIGNMENT PROCEDURE

- Volume control—Maximum all adjustments.
- Connect "B" of radio chassis to ground post of signal generator through .1 Mfd. condenser.

- Connect dummy antenna valve in series with generator output lead.
- Connect output meter across primary of output transformer.
- Allow chassis and signal generator to "heat up" for several minutes.

BAND	SIGNAL GENERATOR		Connection to Radio	Position of Iron Cores (Dial Setting)	Trimmers Adjusted (In Order Shown)	Trimmer Function	Adjustment
	Frequency Setting	Dummy Antenna					
I. F.	465 Kc.	.1 MFD.	Terminal "A" (See Fig. 4)	Iron Cores All the way out	Two trimmers on top (See Fig. 1)	Output I. F.	To maximum output
	465 Kc.	.1 MFD.	Terminal "A" (See Fig. 4)	Iron Cores All the way out	Two trimmers on top (See Fig. 1)	Input I. F.	To maximum output
BROADCAST BAND	1690 Kc.	.1 MFD.	Terminal "A" (See Fig. 4)	Iron Cores All the way out	Trimmer (C4) (See Fig. 4)	Oscillator	To maximum output
	1690 Kc.	200 MMF.	Terminal "B" (See Fig. 4)	Iron Cores All the way out	Trimmer (C3) (See Fig. 4)	Antenna	To maximum output
	1400 Kc.	200 MMF.	Terminal "B" (See Fig. 4)	Turn Dial to 1400 Kc.	Adjust position of antenna coil right or left. (See Fig. 3)	Antenna Coil Adjustment	(See Note "A") To maximum output
	1690 Kc.	200 MMF.	Terminal "B" (See Fig. 4)	Turn Dial to 1690 Kc.	Adjust trimmer (C3) (See Fig. 4)	Antenna	Check for tracking. (See Note "B")

NOTE "A"—The antenna coil assembly is made so that it is movable right or left. When making the adjustment as given in the alignment procedure move the coil assembly very slowly. It can be moved by hand or by pivoting one edge of the blade of a screwdriver in the hole and engaging the blade in the gear teeth of the coil form.

NOTE "B"—After the antenna coil has been tracked at 1400 Kc. it is necessary to check the antenna trimmer (C3) adjustment again at 1690 Kc. If no appreciable change in trimmer adjustment is made the coil is in track. If the trimmer requires considerable change it will be necessary to again adjust the position of the antenna coil at 1400 Kc. These two adjustments should be tried several times until no change of trimmer adjustment is required at 1690 Kc.

nary to check the antenna trimmer (C3) adjustment again at 1690 Kc. If no appreciable change in trimmer adjustment is made the coil is in track. If the trimmer requires considerable change it will be necessary to again adjust the position of the antenna coil at 1400 Kc. These two adjustments should be tried several times until no change of trimmer adjustment is required at 1690 Kc.

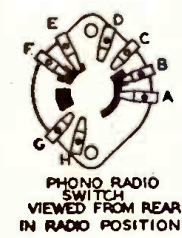
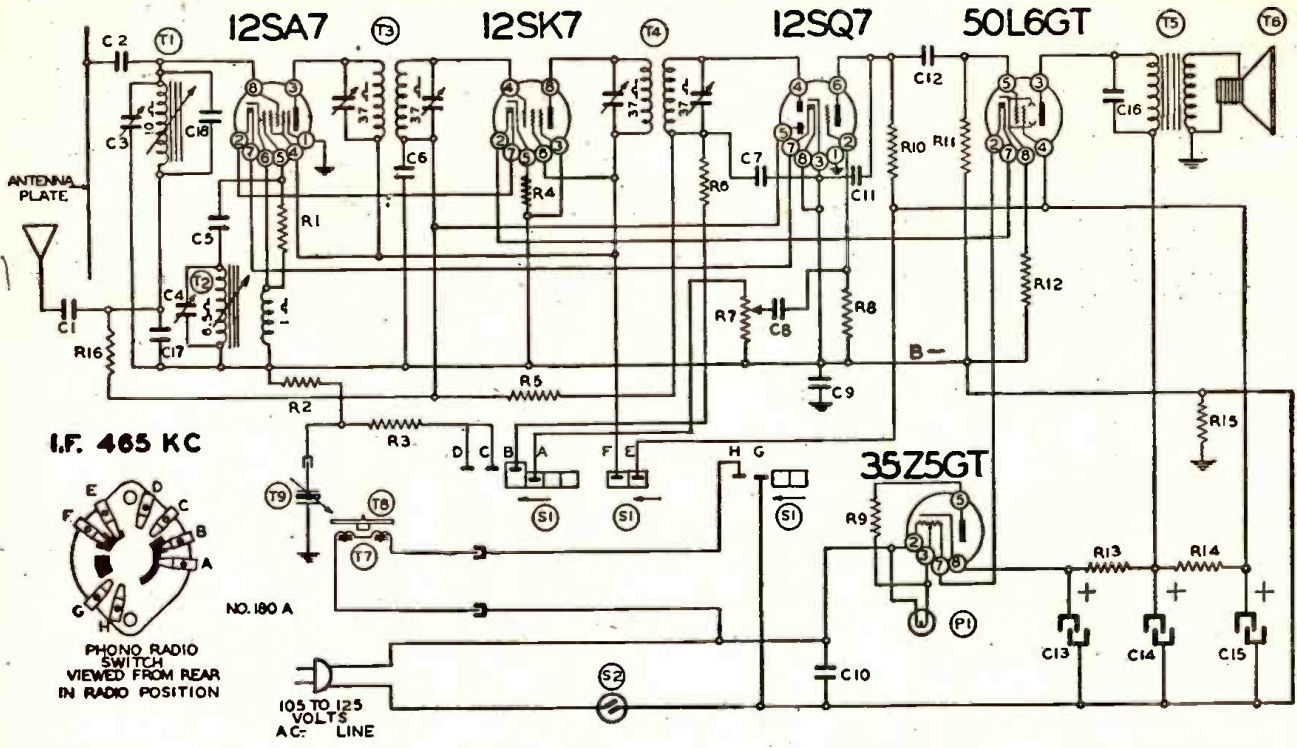

PARTS LIST

- Resistors**
- R1 20M ohm—1/3 w.
 - R2 600M ohm—1/3 w.
 - R3 600M ohm—1/3 w.
 - R4 100 ohm—1/3 w.
 - R5 3 megohm—1/3 w.
 - R6 50M ohm—1/3 w.
 - R7 1/2 megohm—volume control
 - R8 5 megohm—1/3 w.
 - R9 25 ohm—1/2 w.
 - R10 200M ohm—1/3 w.
 - R11 750M ohm—1/3 w.
 - R12 150 ohm—1/3 w.
 - R13 200 ohm—1/3 w.
 - R14 1200 ohm—1 watt
 - R15 200M ohm—1/3 w.
 - R16 200M—1/3 w.
- Condensers**
- C1 .0001 Mica Condenser
 - C2 .0003 mfd. mica
 - C3 Antenna Trimmer
 - C4 Oscillator Trimmer
 - C5 .0001 mica
 - C6 .05 x 200 v.
 - C7 .0001 mica
 - C8 .002 x 500 v.
 - C9 .1 x 400 v.
 - C10 .1 x 400 v.
 - C11 .00025 mica
 - C12 .006 x 500 v.
 - C13 40 mfd. electrolytic—150 w. v.
 - C14 20 mfd. electrolytic—150 w. v.
 - C15 20 mfd. electrolytic—150 w. v.
 - C16 .01 x 400 v.
 - C17 .0008 Mica Condenser
 - C18 .000025 Ceramic Condenser
- Notes:** C3 and C4 in same unit
C13, C14 and C15 are in same unit
- Parts**
- T1 Antenna Coil—Permeability tuning assembly complete
 - T2 Oscillator Coil
 - T3 Input I. F. Coil—465 kc.
 - T4 Output I. F. Coil—465 kc.
 - T5 Output Transformer
 - T6 5" P.M. Speaker
 - T7 Phono Motor
 - T8 Turntable
 - T9 Phono pick up arm
 - S1 Phono Switch
 - S2 Switch on volume control
 - P1 Pilot light T47
- Note:** T1 and T2 in same unit

NOTE "A" THE ANTENNA COIL ASSEMBLY IS MADE SO THAT IT IS MOVABLE LEFT OR RIGHT. WHEN MAKING THE ADJUSTMENT AS GIVEN IN THE ALIGNMENT PROCEDURE MOVE THE COIL ASSEMBLY VERY SLOWLY. IT CAN BE MOVED BY HAND OR BY PIVOTING ONE EDGE OF THE BLADE OF A SCREWDRIVER IN THE HOLE AND ENGAGING THE BLADE IN THE GEAR TEETH OF THE COIL FORM.

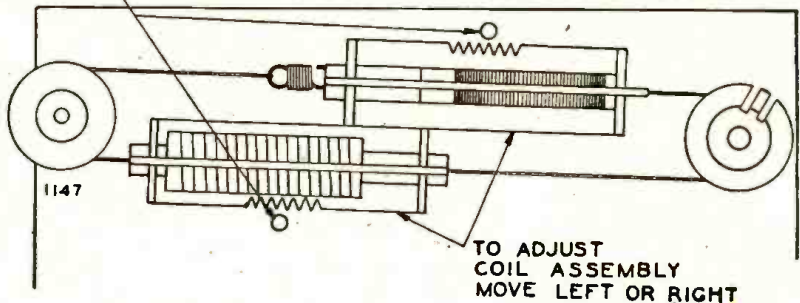

BOTTOM VIEW OF CHASSIS

VOLTAGES MEASURED WITH 1000 OHM PER VOLT VOLTMETER BETWEEN SOCKET TERMINALS AND B-

[A] CANNOT BE MEASURED WITH D.C. VOLTMETER
[B] POINTS OF LINE CONTACT

NOTE: SWITCH SHOULD BE IN RADIO POSITION AND SET CONNECTED TO 117V. 60 CYCLE A.C. SUPPLY SOURCE. NO SIGNAL AND VOLUME CONTROL IN MINIMUM POSITION

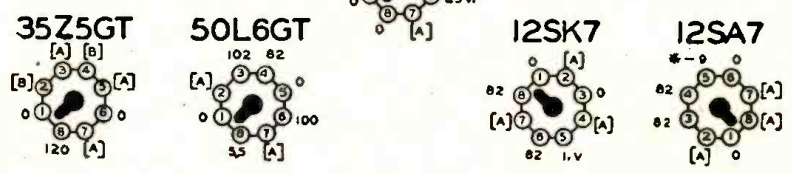

REAR OF CHASSIS

Servicing Notes

Trouble in . . .

CROSLY MODEL 158

Inoperative, weak, crackling reception. All tubes and voltages check O.K.

It was found that the trimmer condenser located on the top left side of the chassis was shorting to ground. This was repaired by removing the rivet, replacing the mica, and remounting with a machine screw.

A. R. GREEN,
Ft. Worth, Texas

ZENITH MODEL 5G500

Radio O.K. on batteries but develops distortion when switched to A.C.

Changing the micamold resistor, (part 62-1096, value 140 ohms) on the 2-section Candohm, will usually clear this up.

These resistors often check O.K. when cold but go wrong when warmed up.

P. T. ADAMS,
Cleveland, Ohio

CROSLY MODEL 132

This set often develops trouble in the first intermediate transformer. Upon examination a small brass strip located at the start of the primary winding and laying against the wooden dowel on which the coil is wound, is found to be the cause of the trouble. In all cases the inside layer of the primary winding had shorted through the insulation to the brass strip. This shorted primary and secondary together.

In some cases the complete transformer was replaced and in others the primary winding was removed and the turns which had shorted to the brass taken off. The transformer is then re-assembled and re-balanced.

ROBERT B. HORRALL,
Olney, Illinois

RCA MODEL 95T1

This set came into the shop with the complaint that a loud squeal appeared every time the volume control was turned up.

I tried several tubes, thinking it was a microphonic, and after checking everything I could imagine, found that plates in the oscillator section of the tuning condenser—which are very near the speaker in this model—were picking up the vibration and causing the squeal.

Cure—small rubber band around stator plates out on end away from rotor plates. Many other tricks may have stopped this, such as wax or maybe a small bit of Scotch tape on the outside stator plates (because I suspect that only the outside plates were picking up the noises).

H. SMITH,
Charlottesville, Va.

BUICK SONOMATIC

In reference to Mr. Yurkovich's Note on the broken spring at the right hand of the push-button assembly, I note that he suggests pulling the condenser and pushbutton assembly out of the set.

This repair can be made with a coil spring without removing any parts. The position of the spring to be used is easily ascertained, and after the trouble is located, the whole repair can be made in a little more than 5 minutes.

H. DALTON JONES,
Spartanburg, S. C.

ZENITH MODEL 6G601

A form of intermittent very difficult to localize often occurs in these portables. It is caused by the ends of the oscillator being unsoldered from the terminals of the coil form. "Sweating" these apparently soldered joints clears up the intermittent.

CHAS. S. ALEXANDER,
New London, Conn.

ATTENTION SERVICEMEN!

Do you have any Servicing Notes available which you would like to bring to the attention of the readers of *Radio-Craft*? If so, send them along and if they are published a six-month subscription to *Radio-Craft* will be awarded you. If your notes are illustrated you will be given a one year subscription.

ZENITH RECEIVERS

Sets using 15 type tube for first detector and oscillator, and powered by a 6-volt A battery.

Set checks O.K. for voltages and resistances, but will not oscillate on low-frequency end of the dial. Some sets will not oscillate at all.

Replace the 9,000-ohm cathode resistor, using 3,000 to 5,000 ohms as may be required to bring the set back to normal.

HOWARD ABERNATHY,
Blakesburg, Iowa

TRUETONE MODEL D1176-D1145

Dead or low and distorted. Tubes check O.K.

Time may be saved in checking this set if you first try the .02-mfd. 400-volt condenser between the grid bias resistor of the 6V6 output and ground. This has been found shorted in about 12 out of 15 sets of this model brought in for service with these symptoms.

Replace with a .02-mfd. condenser rated at 600 volts.

LAMAR BUNN,
West Point, Ga.

DETROLA 360

Set dead. Examination will show oscillator failure, due to weak 1A7-GT.

Cause of this repeated trouble is a gassy 50L6. As the 50L6 cathode current flows through the filament of the 1A7 it raises the filament voltage, which in time ruins the emission of the tube.

Cure: Replace the 50L6-GT. If these tubes are unobtainable, reduce the grid resistor to 250,000 ohms.

J. RALPH MCKENNA,
Randolph, Mass.

SILVERTONE 101.417A OR 4426A

Intermittent reception. All tubes, resistors and by-pass condensers O.K. by test and substitution.

The trouble was found in the "A" side of the DPDT switch which turns on the set. "A" voltage would drop intermittently to so low a value that the set would stop playing, or fade badly.

A new switch was installed, though possibly the old one might have been cleaned up.

HAROLD H. SNYDER,
Roan Mountain, Tenn.

SILVER MODEL 308-C-D

No reception in this set is very often caused by a defective (open) brown resistor of 3500 ohms, R11, connected as shown in the diagram.

Incidentally, the green resistor is a 10,000-ohm unit and the value of the yellow one is 300,000 ohms.

GEORGE ROGAL,
Paris, Ontario

AUTOMATIC MODEL 170

Complaint: Hum.

Before pulling the chassis on this set, note the condition of the pilot light, and replace it if it is out. When this lamp is out the filter system is cut in half.

As this chassis is not easy to remove from the cabinet, a great deal of time may be saved in cases where this is the trouble.

ARTHUR HUGHES,
New Canaan, Conn.

RADIOLA MODEL 1485

This receiver would blow the filament of the 35Z5-GT rectifier tube about every three months, and a 50L6-GT occasionally. Using the proper dial lamp did not remedy the 35Z5 failure. All filter condensers were O.K.

Careful check of the tubes showed that the 12SQ7, 12SA7 and 12SK7 had a considerable leakage from the filament to shield. Since all of the shields were connected to the chassis, the resistance of these tubes was partially shunted out, causing the voltage drop across the 35Z5 and 50L6 filaments to increase to a point which shortened their lives.

The trouble was corrected by installing a new 12SA7, 12SK7 and 12SQ7 (as well as the burned out 35Z5). Had 50L6's been plentiful I would have installed a new one, but as it was O.K. at the time, it was permitted to remain in the set.

STACEY M. FIELDS,
Mobile, Alabama

DEAD SPOTS IN SUPERS

This defect was encountered in Crosley receivers, but would probably be similar in other supers. The sets refuse to oscillate near the low-frequency end of the (broadcast) band.

It was found that the cathode bias resistor on the first-detector-oscillator tube had increased in value, and the tube was therefore getting excessive control-grid bias.

Reducing the resistance in the cathode circuit (new resistor) solved the problem.

LEO STROLLO,
Brooklyn, N. Y.

ATWATER KENT 55-60

Motorboating—all condensers O.K.

Check the R.F. choke coils. A short of only 2 ohms will cause oscillation or motorboating and it is very hard to find the trouble.

ATWATER KENT 310-510

Squeals on all stations. Shadow-tuning light often inoperative or intermittent.

Clean band-switch to clear up oscillation. The light socket on the shadow tuner usually has to be replaced as they make poor contact.

W. G. ESLIK,
Wichita, Kan.

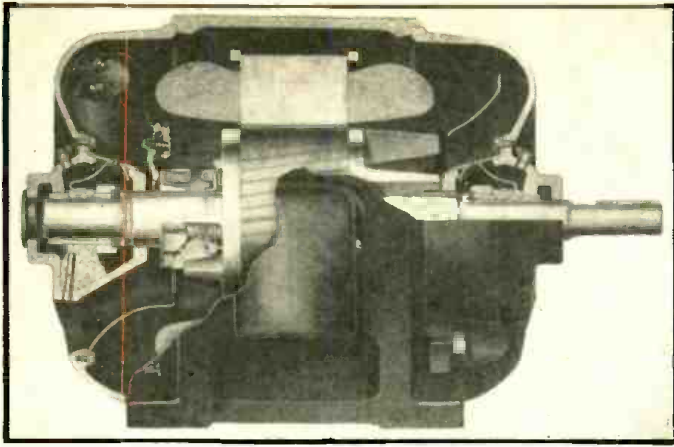

Another type of motor much used in radio work is the single-phase alternator illustrated here. Working on the same principle as the D.C. motor described, the manner of operation is different, to suit the different type of current used. A detailed description of A.C. motor principles may appear in a later issue of RADIO-CRAFT.

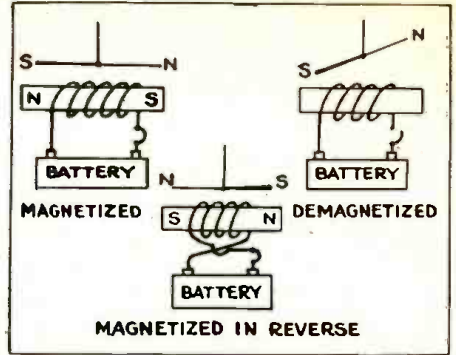

Fig. 4.—How we can change the poles of a magnet.

How and Why MOTORS WORK

By R. H. ROGERS*

If a magnet that is free to turn is brought near a fixed magnet, the free magnet will turn to line itself up with the fixed one with its north and south ends opposite the south and north ends of the fixed magnet. Make this experiment (Fig. 1). This is a fundamental principle of magnetism—*unlike poles attract; like poles repel.*

When the free magnet turned, it did so vigorously, twisting the suspending thread. *It did mechanical work.*

ROTATION ESTABLISHED

Suppose one bar of iron is laid across another and a magnetized needle is suspended by a thread over the crossing point. Since the iron pieces are not magnetized, the suspended magnet can point in any direction (Fig. 2).

Now, if by some means the bars are magnetized and demagnetized so that given poles appear in rotation, the free magnet turns to follow the successive locations of north and south poles. The free magnet is thus made to revolve continuously and we have a miniature motor (Fig. 3).

ELECTROMAGNETS

We have means for rapidly magnetizing and demagnetizing iron and reversing its

*Industrial Engineering Division, General Electric Company.

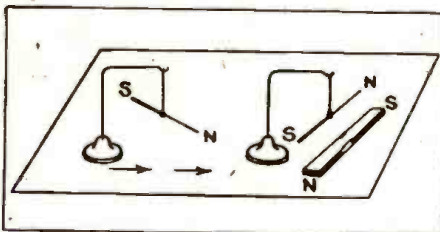

Fig. 1.—The needle, swinging freely, immediately lines up with a magnet placed under it, and its ends assume a polarity opposite to that of the bar magnet below.

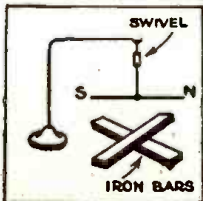

Fig. 2.—With the bars successively magnetized, the needle revolves and follows the steadily rotating magnetic field.

north-south characteristic. A coil of wire around iron will make a magnet of it when electric current is passed through the wire. If the iron is of the proper kind it will lose its magnetism almost instantly when the current is shut off. If the current is started again in the reverse direction the iron will be magnetized with N-S where S-N was before. The polarity is said to be reversed (Fig. 4).

This is an electromagnet—much stronger than a permanent magnet and subject to control, i.e., ON-OFF-REVERSE with a great rapidity.

THE ELECTRIC MOTOR

An electric motor consists of two members, one that is stationary and one that can revolve. Each has electric conductors in or around parts made of thin steel laminations, together with such supports and fastenings as are necessary to make them usable.

Both the stationary member and the revolving member are largely electromagnets since the windings, through which electric

(Continued on page 183)

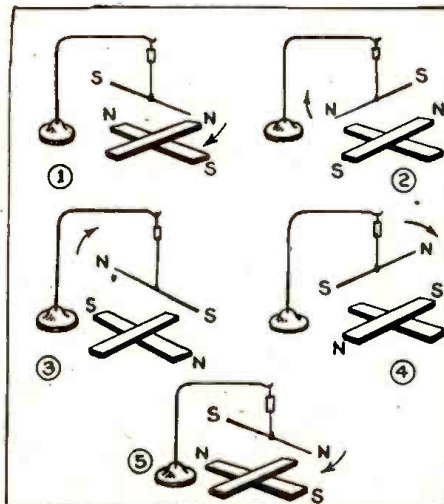

Fig. 3.—Here is the crudest type of electric motor.

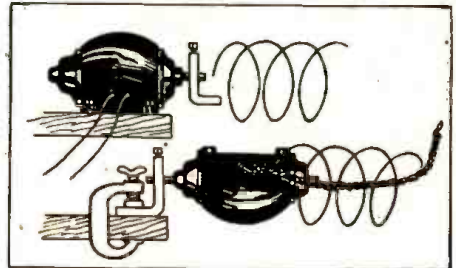

Fig. 5.—Either member may be the stator or rotor.

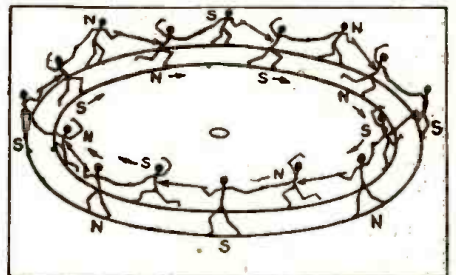

Fig. 6.—Rotation is a series of prods and pulls.

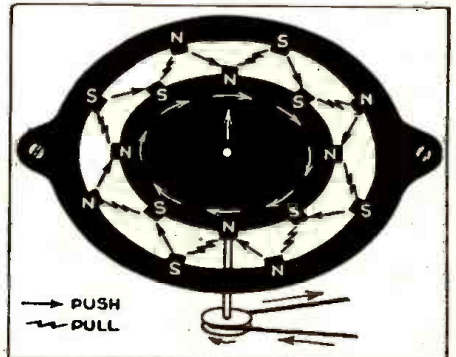

Fig. 7.—Arrowhead N is drawn to the S-pole ahead and is pushed forward by the N-pole behind it.

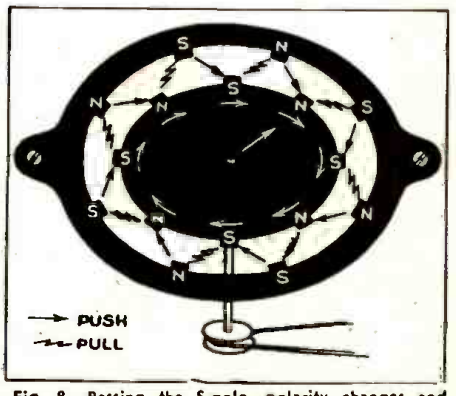
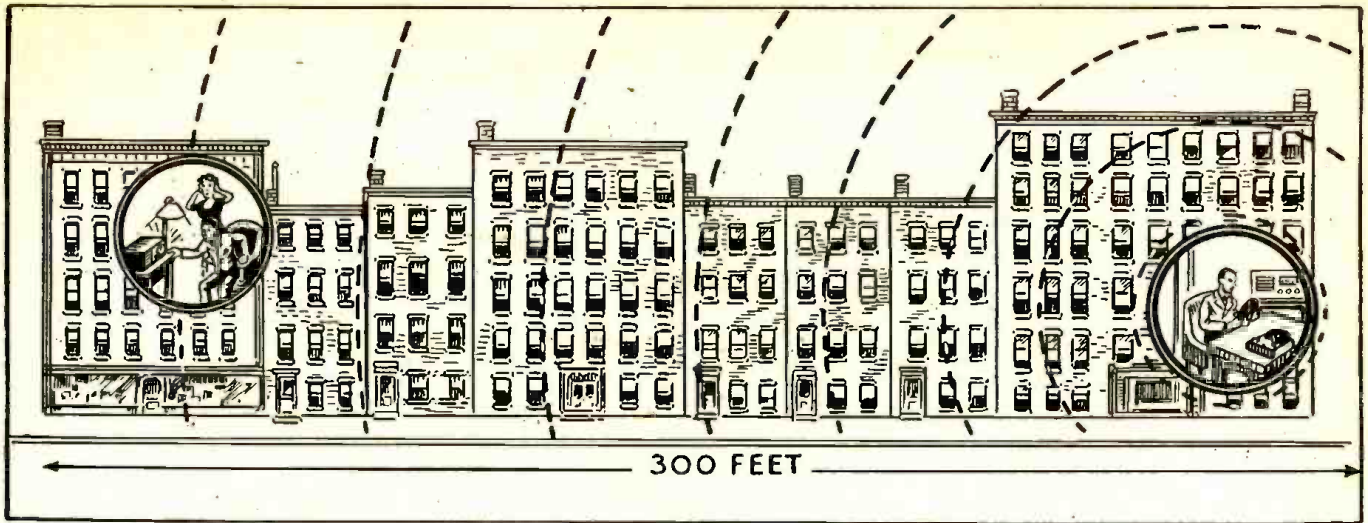

Fig. 8.—Passing the S-pole, polarity changes and N again finds an N-pole behind and an S-pole ahead.



Even with the moderate range of 300 feet, a "wireless" record player may create interference in a radio several doors down the street.

"Illegal" Record Players

SEVERAL readers have inquired as to the legality of small transmitting devices, such as phonograph oscillators, now that all transmission has been banned by government order. Other readers have written in, asking for amplifiers for such devices, so that they can increase signal strength enough to extend their range to a few thousand feet.

In view of this general misunderstanding about the operation of such apparatus, we are reprinting a resume of the FCC rules covering such operation.

The range of such devices is definitely

limited by the Commission's provision that they shall be used for the operation of apparatus at a distance "not greater than

$$\frac{157,000}{\text{frequency (kc.)}} \text{ ft.}''$$

As an example—if the device is being operated at about 550 kc., like many phono oscillators, the permissible range is $157,000 \div 550$, or approximately 285 feet. If the oscillator were operated at the 1500 kc. end of the band, the maximum range permitted would be a little over 100 feet.

In terms of wavelength, the same formula is expressed:

$$\frac{\lambda}{6.28} \text{ meters.}$$

The minimum power required for successful operation is to be used in such devices, and in no case shall the field at a

distance of $\frac{157,000}{f \text{ (kc.)}}$ ft. be in excess of

15 microvolts per meter. The Commission points out that field intensity measuring equipment is not likely to be available to users or servicemen, but that the effect of this ruling is to limit the useful range of such devices—if a signal sufficiently above the noise level is to be produced—to a range not likely to be greater than 30 to 80 feet.

Successful operation of mystery controls, phonograph amplifiers, etc., at distances greater than the limits given is almost certain proof that they are violating the regulations.

All the foregoing is dependent on absolute non-interference with other radio reception, and any interference automatically makes the device illegal, no matter how weak the signal or how small the distance at which picked up.

This is a point not well understood by many who have a pretty clear idea of the maximum range permitted under the regulations. As an example, a phonograph oscillator is used between 550 and 600 kc., the maximum permissible range being in the order of 250 feet. A neighbor in an adjoining apartment—say 30 feet away—hears the phonograph music while listening to a local station. Operation of the oscillator in this instance is clearly illegal, and the transmitted signal must be weakened to a point where it is inaudible to the neighbor when listening to any station on the band.

Should the neighbor, by tuning between two stations and turning up his volume control, be able to hear the transmitted phonograph music, this would hardly render the transmissions illegal (provided the neighbor is within the prescribed range) as such reception could hardly be considered "interference."

NARROWCASTING

ULTRA short radio waves—beamed like light—will be used after the war to perform amazing feats in the home, on the highways and high seas, and in the factory, according to I. E. Mourontseff, one of the pioneers in ultra-high-frequency development and now a member of the Electronics Engineering Department of Westinghouse at Bloomfield, New Jersey.

Radio may be used for treating human disease, cooking without external heat, and guiding ships into fog-bound harbors automatically.

We may reasonably expect that the vast development of the last few years in tube and equipment design and manufacture will help reduce the cost of such radio projects to a practical level.

Among the "feasible applications" in industry for this newest form of radio, Mr. Mourontseff listed such jobs as aiding in the manufacture of safety glass and treating preserved foods after they already are in the jars or packages.

One of the first industrial experiments with ultra high frequency radio which produces short waves was for the de-infestation of wheat in grain elevators contaminated with rice weevil. Laboratory experiments were successful and stirred up a tremendous interest both in this country and abroad.

Vacuum packers were interested in the

possibility of pre-cooking hams and similar products by high frequency radio. Restaurants investigated the future of large "radio cookers" which might be installed in dining rooms for grilling steaks or hot dogs, or toasting bread in front of the customer. Heat would be generated only in the food itself and the food would be cooked from the inside out, giving it a different flavor.

Two factors cooperated in the past to frustrate the initially successful effort to apply ultra high frequency radio to industry. First, the great economic depression retarded development projects in their early stages. Second, the cost of equipment was too high for practical applications. That cost will be reduced by virtue of ceaseless war research, however, and a vast new market lies ahead.

The field of short wave radio seems almost limitless. In the field of medicine it has been found that various sicknesses can be treated by irradiating the body with radio waves. Very short waves can be focused into narrow beams—narrowcast instead of broadcast—and applied to the body for therapeutic treatment at sharply defined places. Radio, for example, can be used for irradiation of kidneys, lungs, stomach and other areas. It also is the most convenient method of heating the entire body. The doctor can administer such a "Turkish bath" right in his office.

Make Your Own Key

Telegraph keys have been almost impossible to obtain, due to military needs and the demand for code practice classes. The author of this story, who unfortunately omitted to give his name and address, has solved this problem neatly.



This home-built key looks like a commercial job.

THE radio experimenter or enthusiast soon finds himself trying to master the Radio Code, to which end a key becomes necessary. The photograph shows a key which was made with few tools and from materials to be found in the average junk box.

The drawings give the general details and dimensions and along with the photograph make the construction nearly self-explanatory. Following is the general outline:—

THE LEVER. This can be made from either brass or iron and should be given a good finish using a fine file and emery cloth. The bending is done with the hands after securing the lever in a vice padded with wood. Positions for holes should be center punched

making sure that it is in its correct position—and apply the hot iron to the nut. After a few seconds remove the iron and if the task is properly carried out the result will be a perfect bond between lever and nut.

The adjustment screws are 3/16" stove bolts to which binding post nuts have been soldered, they make a neat appearance. Lock-nuts should be used to hold the adjustment, in my case, however, the spring adjustment was left without as the fit was pretty snug and did not work loose in operation.

The uprights were made of brass parts taken from an old tuning condenser, hardly any additional work was required to suitably adapt these, they already had the

in the bearing should be unthreaded. If not the spaces between the threads should be filled with solder. After passing through the bearing and uprights binding nuts screwed on at both ends with washers underneath hold it rigidly in position. Washers should be placed between the uprights and sleeve bearing ends. Needless to say the shaft should be a good fit inside the bearing but not tight, it should be lightly oiled. The uprights should be adjusted so that the lever has no side play.

If a suitable spring cannot be found one can be made from hard-drawn brass wire of suitable tension. The wire may be wound on a nail. The finished outside diameter should be about 1/4". The spring is soldered to a flat head bolt which is secured to the base.

The details of the contacts are clearly shown in the photograph and drawings. The platinum points used might be taken from an old auto type relay.

No difficulty should be experienced in obtaining a suitable knob; one might even be made from an empty thread spool; securing it to the lever is a comparatively simple matter.

The base was made of mahogany. All holes are countersunk on the underside with a 1/2" auger. Channels are cut for the connections, one of which runs from under the nut of the bottom contact to one binding post, and the other from under one of the nuts which tightens the bolt that holds down the upright supporting strap.

After all drilling, etc., was completed, the base was stained and given a coat of polish.

The final assembly of the key should offer no difficulty. Binding post nuts were obtained from an old radio receiver and a couple of spark plugs.

If iron is used for the lever it should be kept lightly vaselined to prevent it rusting or it might be given a coat of lacquer. I used mine this way for some time until a friend gave it and some of the other metal parts a light coat of nickel!

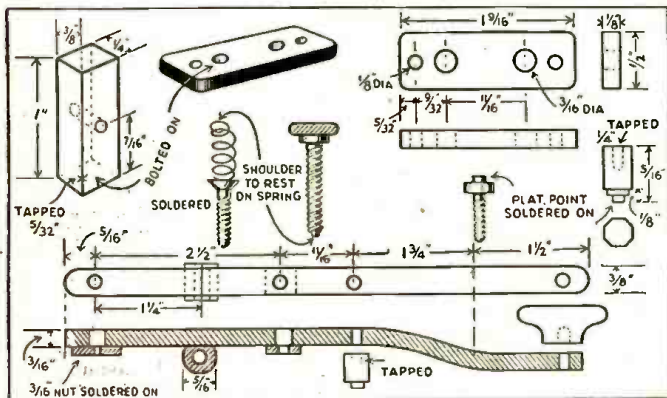

Detail drawing of the small parts. The designer used iron stove bolts in building this key, but the experimenter who still has a few brass machine screws in his junk box will find soldering them much easier. Little difficulty should be experienced in building a key from these drawings.

before boring to make sure that they fall in line.

In this particular model 3/16" stove bolt nuts were sweat-soldered to the underside of the lever for the adjustment screws to work in. This was done simply because I had no 3/16" taps at hand, in which case the lever would be tapped resulting in a simpler job; the lever would also be lower. Incidentally, from the photograph the lever appears to be a bit high but this is partly due to the angle from which the picture was taken.

A word about soldering; first both the surface of the nut and lever should be properly cleaned; next, by means of a good size soldering iron, solder and suitable flux, tin both surfaces, leaving a little more solder than usual on both. Wipe away any dirt that may have formed and apply fresh flux. Finally place the nut on the lever—

tapped holes indicated in the drawing. They are held to the holding down strap by short machine screws, the latter being rigidly held to the base by means of machine screws and nuts.

The sleeve bearing which is sweat soldered to the lever is a short brass spacer slightly flattened on the side which goes against the lever. It should project about 1/64" on each side of the lever.

The shaft passing through the bearing is an iron machine screw. The section working

Radio Lives by Trial and Error

FM PLANNING for the future was the subject of an address by Major Edwin H. Armstrong, inventor of the frequency-modulation system, at a recent address before a meeting of the directors of FM Broadcasters, Inc., which took place in Milwaukee.

He pointed to a long series of mistakes—chiefly in wave length allocations—that have taken place during the history of radio. Most of those took place simply because the men who did the allocating thought at the time that they knew all there was to be known about radio. "The classic example of this," he declared, "was the allocation that gave all the wave lengths below 200 meters to the radio amateurs." (And the amateurs, if we may interpolate a word in their behalf, did a rather neat job of proving that these wave lengths the "experts" thought

worthless were really a most valuable part of the ether.)

"A second blunder," added the Major, "was the assumption that a 5,000-cycle tone range was all that would ever be needed for good broadcasting. This assumption resulted in a permanent impairment of the tone quality transmitted on the standard (AM) broadcast band. A more recent illustration was the allocation of television to wave bands where it had no business to be—that is, where the modulating frequency is a large percentage of the carrier frequency."

In conclusion, he urged that whatever approach is made to the problem of suitable standards and wave length allocations should be sufficiently flexible to allow the correction of errors in judgment. They've been made before and—as he sagely points out—they'll undoubtedly be made again.

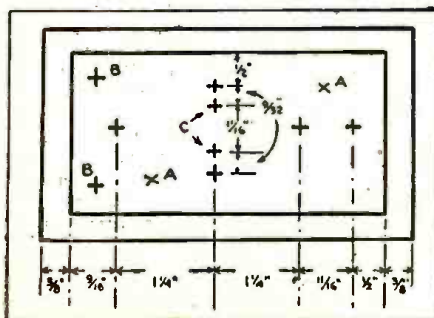

View of base, with positions of all holes.

The Listening Post

Edited By ELMER R. FULLER

THIS is the usual time of the year for better Dx, but so far it seems to be poorer than it has been for several weeks.

With the coming of winter and cold weather, we get away from the usual summer static, and conditions should be ideal. "Radio Brazzaville," FZL, seems to be still the best heard stations on the short wave bands. They come in very fine business on 11.970 megacycles, from 3:45 to 4 pm.; 4:45 to 5 pm.; and 7:45 to 8 pm. Times are E.W.T. as are all others in the list. The Italian stations at Rome have not been heard on the air since the evening of September 8th, and will probably not be heard again until they are back in Italian or Allied Nations control. It has been reported by the German stations that the Italian transmitters would be removed to Germany, and set up to aid the fatherland in spreading their doctrine.

ZFA3 on 3.352 megacycles, formerly ZFA1 on 6.130 megacycles, in Hamilton, Bermuda, requests reports on their reception in this

country. The schedule is Mondays, at 8 to 8:45 pm. The address to which reports should be sent is "Bermuda Broadcasting Board, Hamilton, Bermuda."

Many stations on our list have been marked in this issue as not being heard in several weeks on certain frequencies. These will be withdrawn from our list entirely, if they are not reported in the near future. Several are underground stations, and have probably changed frequencies, schedules, and identification. Please send us any information you may have in regard to them.

The Japanese transmitters at Tokyo have been coming in better during the past month, and will probably increase in signal strength during the coming winter months. At present they come on the air about 6 or 6:15 in the evening, and in this section (east coast) they fade out of the picture about 7 or 7:30. One or two nights we were able to hear them until 8:30 or 9 pm. The announcers use English most of the time,

and are therefore quite easily identified.

Reports are increasing in number, and we hope to see them increasing more in the future. Last month they were received from the following: Gilbert L. Harris, North Adams, Massachusetts; Robert A. Grimm, Macon, Georgia; The Office of War Information, New York City; Robert K. Kobb, Erie, Pennsylvania; Robert S. Duggan, Jr., Macon, Georgia; Bill Buchle, Jr., Ferguson, Missouri; Kenneth Noyes, Los Angeles, California; Albert Simanas, Easton, Pennsylvania; Jerry Nankervis, Westminster, California; Joe Sedik, Chicago Heights, Illinois; Richard Purdy, Brooklyn, New York; and the Consul General of Switzerland, New York City.

At last we have been able to compile a list of the FM (frequency modulated) stations which are now in operation. Many of our readers have requested this for some time, so here it is. Some of these are experimental stations, and some are commercial.

Call	Frequency	Location	Call	Frequency	Location	Call	Frequency	Location
WIXTG	43.400	Holden, Massachusetts	W45D	44.500	Detroit, Michigan	W63NY	46.300	New York City
WIXSN	42.600	Springfield, Massachusetts	W45BR	44.500	Baton Rouge, Louisiana	W65H	46.500	Hartford, Connecticut
W2XMN	43.000	Alpine, New Jersey	W45CM	44.500	Columbus, Ohio	W67B	46.700	Boston, Massachusetts
W2XMN	42.800	Alpine, New Jersey	W45V	44.500	Evansville, Indiana	W67C	46.700	Chicago, Illinois
W2XMN	117.430	Alpine, New Jersey	W47A	44.700	Schenectady, New York	W67NY	46.700	New York
WTXQR	45.900	New York City	W47NV	44.700	Nashville, Tennessee	W69PH	46.900	Philadelphia, Pennsylvania
W2XWG	45.100	New York City	W47NY	44.700	New York City	W71NY	47.100	New York City
W3XO	43.200	Georgetown, D. C.	W47P	44.700	Pittsburgh, Pennsylvania	W71SB	47.100	South Bend, Indiana
W9XER	46.500	Kansas City, Missouri	W47R	44.700	Rochester, New York	W73PH	47.300	Philadelphia, Pennsylvania
W9XYH	43.000	Superior, Wisconsin	W49D	44.900	Detroit, Michigan	W75C	47.500	Chicago, Illinois
K45LA	44.500	Los Angeles, California	W49FW	44.900	Fort Wayne, Indiana	W75NY	47.500	New York City
K49KC	44.900	Kansas City, Missouri	W49PH	44.900	Philadelphia, Pennsylvania	W75P	47.500	Pittsburgh, Pennsylvania
W31NY	43.100	New York City	W51C	45.100	Chicago, Illinois	W81SP	48.100	Springfield, Massachusetts
W39B	43.900	Mt. Washington, New Hampshire	W51R	45.100	Rochester, New York	W85A	48.500	Schenectady, New York
W39NY	43.900	New York City	W53H	45.300	Hartford, Connecticut	WBKY	42.900	Beattyville, Kentucky
W41MM	44.100	Winston-Salem, North Carolina	W53PH	45.300	Philadelphia, Pennsylvania	WNYE	42.100	New York City
W43B	43.300	Boston, Massachusetts	W55M	45.500	Milwaukee, Wisconsin	WBEZ	42.500	Chicago, Illinois
			W57PH	45.700	Philadelphia, Pennsylvania	WBOE	42.500	Cleveland, Ohio
			W59C	45.900	Chicago, Illinois	KALW	42.100	San Francisco, California
			W59NY	45.900	New York City	WIUC	42.900	Urbana, Illinois

Mc.	Call	Location and Schedule	Mc.	Call	Location and Schedule	Mc.	Call	Location and Schedule
3.352	ZFA3	HAMILTON, BERMUDA; Mondays, 8 to 8:45 pm.	6.010	CJCR	SYDNEY, NOVA SCOTIA; Monday to Friday, 7 to 11 am; Saturday, 6:45 to 11 am; Sunday, 8 to 11 am.	6.060	WCDA	NEW YORK CITY; Mexican beam, 7:15 pm to 2 am.
4.107	HCJB	QUITO, ECUADOR; evenings.	6.020	—	GEORGETOWN, BRITISH GUIANA; not heard in several weeks.	6.070	CFRX	TORONTO, CANADA; Sundays, 9 am to 12 midnight; Monday to Friday, 7:30 am to 12:05 am; Saturday, 7:30 am to 12:45 am.
4.70	ZQI	KINGSTON, JAMAICA; not heard in several weeks.	6.02	—	"GUSTAV SIEGFRIED EINS"; not heard in several weeks.	6.080	WLWK	CINCINNATI, OHIO; European beam, 12:15 to 4:30 am; West South America beam, 8:30 pm to midnight.
4.92	YVSRN	CARACAS, VENEZUELA; evening transmissions.	6.030	HP5F	COLON, PANAMA; Unreported in several weeks.	6.090	CBFW	VERCHERES, CANADA; daily, 7:30 am to 11:30 pm (in French).
5.44	—	MOSCOW, U.S.S.R.; not heard in several weeks.	6.030	CFVP	CALGARY, CANADA; Sunday, 10 am to 1:30 am; Monday to Saturday, 8:30 am to 2 am.	6.09	ZNS2	NASSAU, BAHAMAS; Sundays, off at 10:05 pm.
5.875	HRN	TEGUCIAGALPA, HONDURAS; 7 pm to midnight; Sundays, off at 10:45 pm.	6.03	DXP	BERLIN, GERMANY; North American beam, evenings to 1:30 am.	6.095	OAX4H	LIMA, PERU.
5.875	TIGPH	SAN JOSE, COSTA RICA.	6.040	WRUN	BOSTON, MASSACHUSETTS; European beam, 2:15 to 4 am; Central America beam, 7:30 pm to 2 am.	6.100	COCO	HAVANA, CUBA, evenings.
5.935	PJCI	CURACAO, NETHERLANDS WEST INDIES; 7:45 to 10:38 pm.	6.04	COBF	HAVANA, CUBA; not heard recently.	6.110	GSL	LONDON, ENGLAND; North America beam, 6:45 pm to 12:45 am.
5.980	VONH-VONG	ST. JOHNS, NEWFOUNDLAND; 7:30 to 8:15 pm; also heard in mornings.				6.120	WKTS	NEW YORK CITY; North African beam, 11:45 pm to 3:30 am.
6.000	ZFY	GEORGETOWN, BRITISH GUIANA; 3:15 to 8:20 pm.						
6.005	CFCX	MONTREAL, CANADA; Sunday, 7:30 am to 12 midnight; Monday to Saturday, 6:45 am to 12 midnight.						

Mc.	Call	Location and Schedule	Mc.	Call	Location and Schedule	Mc.	Call	Location and Schedule
6.120	—	BERLIN, GERMANY; North American beam, variable times.	7.250	KGEI	SAN FRANCISCO, CALIFORNIA; Oriental beam, 1 am to 1 pm.	9.48	—	MOSCOW; U.S.S.R.; not heard in several weeks.
6.120	LRXI	BUENOS AIRES, ARGENTINA; "Radio El Mundo"; 9 to 12 pm.	7.260	GSU	LONDON, ENGLAND; North American beam, 5:15 pm to midnight.	9.482	—	"GUSTAV SIEGFRIED EINS"; not heard in several weeks.
6.12	—	"GUSTAV SIEGFRIED EINS"; no reports for several weeks.	7.28	VLI9	SYDNEY, AUSTRALIA; Eastern North America (English) 8 am.	9.490	KRCA	SAN FRANCISCO, CALIFORNIA; Oriental beam, 1 am to 1 pm.
6.130	XGOY	CHUNKING, CHINA; East Asia and South Seas 7:35 to 9:55 am; North American beam, 10 to 11:30 am.	7.290	DJX	BERLIN, GERMANY; variable times, North American beam; news in English at 7 pm and other times.	9.490	WCBX	NEW YORK CITY; Latin American beam, 5 to 11:30 pm.
6.130	COCD	HAVANA, CUBA; 7 pm to midnight.	7.31	2RO19	ROME, ITALY; off since September 8th.	9.50	XEWW	MEXICO CITY, MEXICO; evening transmissions.
6.130	CHNX	HALIFAX, NOVA SCOTIA; Sundays, 8 am to 6:55 pm; Monday to Thursday, 6:45 am to 10:15 pm; Friday and Saturday, 6:45 am to 11 am.	7.440	—	LONDON, ENGLAND; North America beam, 10:35 pm to midnight.	9.505	JLG2	TOKYO, JAPAN; North America beam, 12 noon to 2:40 pm.
6.140	WBOS	BOSTON, MASSACHUSETTS; European beam, 4 to 5:30 am.	7.565	WKLJ	NEW YORK CITY; North African beam, midnight to 3 am.	9.520	—	GENEVA, SWITZERLAND; not heard in recent weeks.
6.145	HJDE	MEDELLIN, COLOMBIA; not heard recently.	7.565	KWY	SAN FRANCISCO, CALIFORNIA; daily, 8:30 to 10:30 am; Sundays, 9:30 to 10:30 am.	9.52	DZD	BERLIN, GERMANY; North America beam, evenings.
6.150	CJRO	WINNIPEG, CANADA; 6 to 11 pm.	7.565	WKTS	NEW YORK CITY; North African beam, 3:45 to 5 am; 8 to 11:30 pm.	9.52	DXLI3	PARIS, FRANCE; relays Berlin to North America, 5:30 pm to midnight.
6.160	CBRX	VANCOUVER CANADA; 10:30 am to 2:30 am.	7.575	WRUA	BOSTON, MASSACHUSETTS; North African beam, 7:45 to 11:45 pm.	9.523	ZRH	JOHANNESBURG, SOUTH AFRICA; unreported for some time.
6.165	TILS	SAN PEDRO, COSTA RICA.	7.575	WLWO	CINCINNATI, OHIO; European beam, 12:15 to 2:30 am.	9.530	WGEA	SCHENECTADY, NEW YORK; 3:30 to 6 am, European beam.
6.170	WCBX	NEW YORK CITY; European beam, 11:45 pm to 3 am.	7.660	YNDG	LEON, NICARAGUA; not heard in several weeks.	9.530	WGEO	SCHENECTADY, NEW YORK; East South America beam, 5:30 pm to midnight.
6.180	HJCX	BOGOTA, COLOMBIA; off at 11:48 pm.	7.805	WRUL	BOSTON, MASSACHUSETTS; North African beam, 2:15 to 6 am.	9.535	SBU	MOTALA, SWEDEN; not heard for several weeks.
6.190	DXG	BERLIN, GERMANY.	7.820	WKRD	NEW YORK CITY; European beam, 6:45 pm to 4:45 am.	9.535	HER4	BERNE, SWITZERLAND; North American beam, evenings except Saturdays, 9:30 to 11 pm.
6.190	WGEO	SCHENECTADY, NEW YORK; 12:15 to 3:15 am, European beam.	7.832	WBOS	BOSTON, MASSACHUSETTS; East South America beam, 8:30 pm to midnight.	9.535	JZI	TOKYO, JAPAN; 11 am to 12:30 pm.
6.19	—	"GUSTAV SIEGFRIED EINS"; not heard recently.	7.950	—	ALICANTE, SPAIN; off at 6 pm daily.	9.54	VLG2	MELBOURNE, AUSTRALIA; Eastern North America beam, (English) 8 am; Asia beam (French, Thailand) 9 am.
6.210	—	"DEUTSCHER KURZWELLEN SENDER ATLANTIC"; evenings; variable times.	8.000	—	ATHENS, GREECE; heard 3 to 6 pm daily.	9.543	XEFT	MEXICO CITY, MEXICO; not heard in several weeks.
6.235	—	"GUSTAV SIEGFRIED EINS"; not heard recently.	8.030	FXE	BEIRUT—LEBANON; unreported in recent weeks.	9.545	—	KOMSOMOLSK, SIBERIA, U.S.S.R.; not heard in several weeks.
6.243	HIIN	CIUDAD TRUJILLO, DOMINICAN REPUBLIC, evenings.	8.484	XPSA	KWEIYANG, CHINA; 7:30 am to 12:00 noon.	9.545	—	"GUSTAV SIEGFRIED EINS"; not heard in several weeks.
6.280	HIIZ	CIUDAD TRUJILLO, DOMINICAN REPUBLIC.	8.664	COJK	CAMAGUEY, CUBA; daytime.	9.562	OAX4T	LIMA, PERU; unreported for some time.
6.345	HER4	BERNE, SWITZERLAND; 9:30 to 11 pm daily except Saturday.	8.70	COCO	HAVANA, CUBA; daytimes.	9.565	JRAK	PARAO, PALAU GROUP (JAPANESE); 7 to 9:30 pm.
6.370	WKTM	NEW YORK CITY; European beam, 8:15 pm to 5 am.	8.83	COCQ	HAVANA, CUBA; daytimes.	9.570	KWID	SA FRANCISCO, CALIFORNIA; Australian beam, 3 to 6:15 am.
6.405	TGQA	QUEZALTENANGO, GUATEMALA; 9 pm to 2 am.	8.930	KES2	SAN FRANCISCO, CALIFORNIA; Oriental beam, 6:15 am to 1 pm.	9.570	WRUA	BOSTON, MASSACHUSETTS; North African beam, 5:45 to 7:30 pm.
6.47	COHI	SANTA CLARA, CUBA; afternoons and evenings.	8.942	COKG	SANTIAGO, CUBA; not heard in several weeks.	9.57	KWIX	SAN FRANCISCO, CALIFORNIA; South America beam, daily, 8 pm to 12:45 am; Oriental beam, 1 to 2:45 am; 7:30 am to 4:45 pm.
6.480	TGWB	GUATEMALA CITY, GUATEMALA; 7 am to 8:10 pm daily except Saturdays.	8.96	AFHQ	ALGIERS; not reported in several weeks.	9.580	GSC	LONDON, ENGLAND; North American beam, 5:15 pm to 12:45 am.
6.485	HI2T	SAN FRANCISCO DE MACORIS, DOMINICAN REPUBLIC; no reports received.	9.04	—	FRENCH EQUATORIAL AFRICA; "Radio Club," not reported in some time.	9.58	VLG	MELBOURNE, AUSTRALIA; Western North America beam (English) 11 am.
6.700	TIEP	SAN JOSE, COSTA RICA; "La Voz del Tropico."	9.125	HAT4	BUDAPEST, HUNGARY; 9:15 to 9:30 pm; 10:15 to 10:30 pm.	9.59	WLWO	CINCINNATI, OHIO; West South America beam, 7 pm to midnight.
7.000	WGEA	SCHENECTADY, NEW YORK; Brazilian beam, 8:30 to 11:30 pm.	9.185	CQCQ	HAVANA, CUBA; afternoons.	9.59	—	"VOICE OF FREE INDIA"; unreported in recent weeks.
7.014	CMZI	HAVANA, CUBA; 11 pm to 12:10 am.	9.21	COCX	HAVANA, CUBA; afternoons.	9.59	—	"NATIONAL CONGRESS RADIO"; unreported in recent weeks.
7.037	EAJ3	VALENCIA, SPAIN; 4 to 6 pm.	9.250	COBQ	HAVANA, CUBA; relays CMCQ evenings.	9.595	—	ATHLONE, IRELAND; not heard for several weeks.
7.12	GRM	LONDON, ENGLAND; 8:15 pm to 4 am.	9.255	—	BUCHAREST, RUMANIA; 4 to 5 pm.	9.610	ZYC8	RIO DE JANEIRO, BRAZIL; 6 to 10 pm.
7.15	GRT	LONDON, ENGLAND; 10:45 pm to midnight.	9.29	HI2G	CIUDAD TRUJILLO, DOMINICAN REPUBLIC; Sunday afternoons.			
7.18	CMZI	HAVANA, CUBA; daytimes.	9.35	COBC	HAVANA, CUBA; afternoons.			
7.230	KWID	SAN FRANCISCO, CALIFORNIA; 6:30 am to 12:45 pm, Oriental beam.	9.415	OAX4W	LIMA, PERU; "Radio America"; 9 pm to midnight.			
7.230	—	ROME, ITALY; off since September 8th.	9.437	COCH	HAVANA, CUBA; evenings.			
7.24	DXJ	BERLIN, GERMANY; 11 to 11:45 am.	9.464	TAP	ANKARA, TURKEY.			
			9.47	JZHA	HONG KONG; not heard in several weeks.			

(Continued on page 173)

Latest Radio Apparatus

PLASTIC INDICATOR LAMP

Electronics Dept., General Electric Co.
Schenectady, N. Y.

THE special feature of this small molded plastic indicator lamp is a lock-on color cap which cannot be shaken loose and will not "freeze" to the base. As many as five circuits can be identified on one panel by the use of five different color caps—amber, red, green, white and blue.

The lamp is supplied ready for mounting. The base is mounted directly to the back of the instrument panel and the color cap is screwed into the base through the panel. A coil spring applies constant pressure to the base of the lamp bulb to maintain a good electrical contact. The lamp takes 6- to 8-volt bulbs.

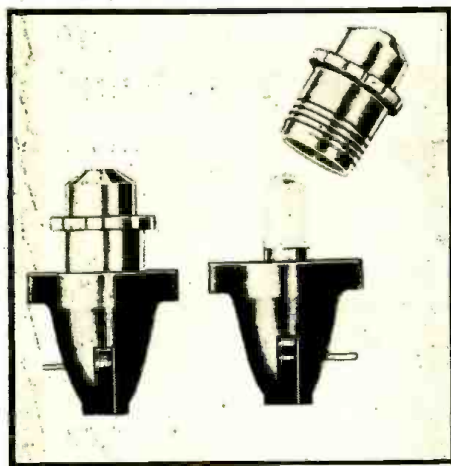

Applications include radio transmitters, and any other equipment or control device where a glow lamp is needed to show that the device or circuit is on or off. —Radio-Craft.

FREQUENCY METER

North American Philips Co.
Doobs Ferry, N. J.

A NEW direct reading frequency meter with an accuracy of 2% retained over the full range of 50,000 cycles is announced.

This has wide applications as a laboratory test instrument, for testing quartz crystals, for use in a wow meter for phonograph motors and for experimental work as the base of a frequency modulation indicator.

When combined with a photoelectric cell, light source and amplifier, the instrument can be used as a speed indicator to read speeds usually difficult to determine, such as those encountered with ultra speed centrifuges.



This Norelco frequency meter drives a recorder without use of auxiliary amplifiers. An overload cut-out protects recorder from damage.

The maximum frequency is 50,000 cycles with six ranges, 0-100; 0-500; 0-1000; 0-5000; 0-10,000; and 0-50,000. Accuracy of 2% is retained over entire range of 50,000 cycles. Each frequency range can be individually adjusted for maximum accuracy.

Frequency is indicated directly on front panel of meter or on separate recorder. The meter has an input impedance of 100,000 ohms or over. It will measure frequency regardless of input signal voltage variations between 1/2 and 200 volts. Stability is maintained with line voltage variations between 105 and 125 volts.

The meter, which does not use D.C. amplifiers, is designed either for relay rack or cabinet mounting. —Radio-Craft.

COMMUNICATIONS SWITCHES

Audio Development Co.
Minneapolis, Minn.

KEY switches, designed for quiet, dependable operation, have been made available in this recent line, intended for telephone switchboard and other wartime communications uses.

Allowing for a maximum of seven springs in each quadrant of the switch, they provide a wide variety of locking and non-locking switching combinations. Silver alloy contacts are standard. Special contact materials can be supplied when desirable. Key switches are supplied with or without mounting plates.

Also available for prompt delivery are the new Audio Development Company telephone type jacks. They feature welded box construction assuring rigid alignment of all parts. Non-aging springs provide permanent

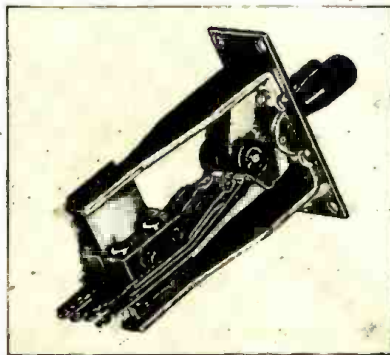

tension. Additional springs allow for the switching of auxiliary circuits as desired. They can be supplied for all standard two and three circuit telephone type plugs. —Radio-Craft.

RADIO TRAINING KIT

Allied Radio Corp.
Chicago, Illinois

A MODERN radio receiver kit, this unit is especially developed for illustrating theory and practices now being covered in basic or pre-induction radio training. It is now available to all schools and colleges conducting war training programs. This

5-tube kit permits progressive study of basic receiver subjects such as rectification, filtering, detection, R.F., I.F., and A.F. amplifications, etc.

The kit consists of all necessary parts, wire, hardware, solder, tubes, and speaker for the construction of a 5-tube AC-DC superhet receiver of advanced up-to-the-minute design. Chassis is completely formed punched and rust-proofed. The only tools needed for assembly are screwdriver, pliers and soldering iron.

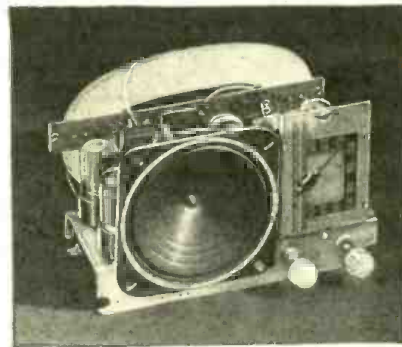

Circuit includes many outstanding features such as oscillator biased R.F. and I.F. stages, contact-potential biased audio stage, inverse feedback, automatic volume control, high capacity filtering, self-contained antenna and others. —Radio-Craft.

RESONANCE METER

Erco Radio Laboratories, Ltd.
Hempstead, N. Y.

A NEW resonance meter, under the type number MW-60, has just been made available to the industry.

This sensitive indicator meets the need for providing a convenient and accurate means of determining resonance in oscillators and transmitters; standing wave ratios, transmission lines, antenna systems, tank circuits, coupling devices, and modulation indication.

Ruggedly constructed, it is well adapted for resonance measurement of transmitting equipment in the field and laboratory, such as absolute altimeters, blind landing markers, glide path markers, airport traffic control, weather teletype, and broadcast relay circuits. —Radio-Craft.

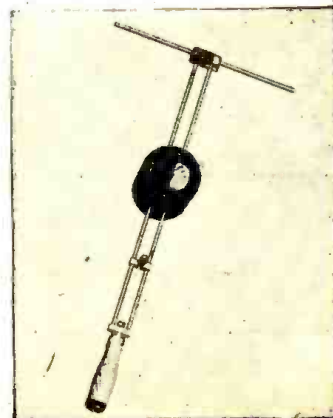

GHIRARDI'S ORIGINAL, AND BY FAR THE BEST!

Used by
More U. S. Army Signal
Corps, Navy, and Civilian
Schools and Colleges
Than any Other Book
Ever Published on
the Subject!

RADIO PHYSICS COURSE

WRITTEN BY ALFRED A. GHIRARDI

**DON'T BE MISLED!
COMPARE BEFORE YOU BUY!
HERE ARE THE FACTS**

Ghirardi's famous RADIO PHYSICS COURSE has been used to give more people their basic Radio-Electronic training than any other ever published. It is more widely praised by the men who have had to learn Radio quickly (and from "scratch") in the armed forces—and by men who have already obtained good paying Radio-Electronic jobs in industry! Nine out of ten of them (as proved by a recent survey) will tell you that Ghirardi's famous RADIO PHYSICS COURSE is unquestionably their first choice, as the easiest-to-learn from, most thorough and inexpensive Radio book on the market.

So sure are we that RADIO PHYSICS COURSE is the best in the field that we offer you the unqualified 5-day MONEY-BACK GUARANTEE stated below. No matter what kind of Radio Training you may be offered—see it before you buy it! Compare it page for page, instruction for instruction, with what Ghirardi gives you for only \$5.

UNSOLICITED TESTIMONIALS

"Nine of my friends have had me get them this book, and all praise it as much as I do." M. L. Birkett, Aircraft Radioman, Tulsa, Okla.

"To me, this book has really been my instructor. With its aid, I passed the Army Communications Cadet exam." Pfc. B. Bragin, Scott Field, Ill.

"I owe my Corporal stripes to Mr. Ghirardi and his Radio Physics Course!!!" Cpl. A. Greenfield, Radio Repair, Ft. Dupont, Del.

... AND WE HAVE HUNDREDS MORE!

You've never seen any Radio Book like Ghirardi's RADIO PHYSICS COURSE—because there isn't any other like it at any price! It is larger, better illustrated, more complete, easier to understand—and starts right at the beginning with over 300 of its 972 pages devoted to complete explanation of essential Electrical fundamentals alone!

EVEN IF YOU DON'T KNOW ANY THING ABOUT RADIO!

This big book takes no previous Radio knowledge for granted. Here, for instance, is a letter from K. Chee of Pretoria, South Africa, which is typical of thousands received from all over the world: "A little while back, I had no knowledge of Radio whatsoever. I had tried to learn through a few textbooks but gave it up—until I took another chance and wrote to you for RADIO PHYSICS COURSE. In three months I had mastered the contents and if it were not for your book, I would not be a Radio Expert today. I only wish I could shake hands with Mr. Ghirardi personally. Thanks a million for your assistance!"

A \$50 VALUE FOR ONLY \$5 COMPLETE! If you bought this big book as a course, you might easily expect to pay \$50 or more for such complete instruction. You buy it complete, however, for only \$5. Get started at once by mailing the coupon—TODAY! Our MONEY-BACK GUARANTEE enables you to examine this great book for 5 days—and then get every cent of your money back if you're not more than satisfied!

SCOPE OF 36 COURSES IN ONE BIG BOOK

Actually, Ghirardi's RADIO PHYSICS COURSE gives you the scope of 36 different courses in one—packed into an easy-to-follow 972-page book with 508 clear illustrations, and 856 self-testing review questions. What other books and courses skim over, it explains fully so you cannot fail to understand. That's why both civilian and military Radio-Electronic instructors everywhere report that their students learn far more quickly and easily from this than from any other Radio text.

A POWERFUL SERVICING COMBINATION!



MODERN RADIO SERVICING—Ghirardi's Modern Radio Servicing is the only single, inexpensive book that gives a thorough and easily understandable course in radio repair work, including an explanation of all the radio test instruments; receiver trouble-shooting procedure; circuit analysis; parts testing and repair; maintenance, etc. 1396 pages with 706 illus., 720 self-review questions, 766 different topics! Only \$5 complete (\$5.50 foreign).

1300 pages
706 illus.
Price \$5



RADIO TROUBLE-SHOOTER'S HANDBOOK—This big 744-page book is a complete guide to trouble diagnosing, locating, and fast repairing on practically every type of Radio receiver. Eliminates extensive testing—helps you do two jobs in time normally required for one—repair cheap sets profitably—substitute available tubes and parts properly—train new helpers, etc. Pays for itself first time you use it!

744 pages
(manual-size)
75 sections
152 illus.
Price \$5

YOUR MONEY BACK...

If Ghirardi's big 972-page Radio Physics Course doesn't teach you the fundamentals of Radio and Electricity faster, easier, and at less cost than any other book!

Radio & Technical Division of Murray Hill Books, Inc., Dept. RC123
232 Madison Ave., New York 16, N. Y.

Enclosed find \$..... for books checked; or send C.O.D. for this amount plus postage. If I am not fully satisfied, I may return the books within 5 days and receive my money back.

RADIO PHYSICS COURSE

\$5 (\$5.50 foreign)

3rd. Edit. RADIO TROUBLE-SHOOTER'S HANDBOOK \$5 (\$5.50 foreign)

SPECIAL MONEY-SAVING COMBINATION—Modern Radio Servicing with the Handbook. \$9.50 (\$10.50 foreign)

MODERN RADIO SERVICING \$5 (\$5.50 foreign)

Name
Address
City (and Dist. No.) State

MAIL THIS NOW!

REPAIR ANY KIND OF RADIO EQUIPMENT

PREPARE YOURSELF FOR A BETTER JOB AT HIGHER PAY IN THE RADIO-ELECTRONIC FIELD

The Question Box

All queries should be accompanied by a fee of 25c to cover research involved. If a schematic or diagram is wanted, please send 50c, to cover circuits up to five tubes; for five to eight tube circuits, 75c; over eight tubes, \$1.00.

Be sure to send the fullest possible details when asking questions. Give names and MODEL NUMBERS when referring to receivers. Include schematics of your apparatus whenever you have such. Serial numbers of radios are useless as a means of identification.

All letters must be signed and carry FULL ADDRESS. Queries will be answered by mail, and those of general interest reprinted here. Do not use postcards—postmarks often make them illegible.

No picture diagrams can be supplied. Back issues 1942, 25c each; 1941, 30c each; 1940, 35c each. Any issue, prior to 1940, if in stock, 50c per copy.

HOW TO DESIGN A VOLTAGE DIVIDER

? I have built up a power pack for portables from your magazine. This calls for a 25,000-ohm, 50-watt voltage divider with a slider, which I cannot now obtain.

How may I obtain the voltages, such as B-minus, B-plus 135 and 250 volts and B-plus 22 volts?

Or what might I use in place of the divider?—R. T., Brooklyn, N. Y.

A. It is easy to design a voltage divider, if you know Ohm's Law, and if you start at the negative end.

The output voltage of your pack and the amount of current needed at each tap must be known or closely estimated. The tube manual will tell you how much current you may expect your tubes to draw, and your voltage when these currents are drawn may be taken as two-thirds that of the no-load voltage of the pack, for a first rough approximation.

Assuming that your detector will draw about 2.5 Ma. at about 22 volts, and the

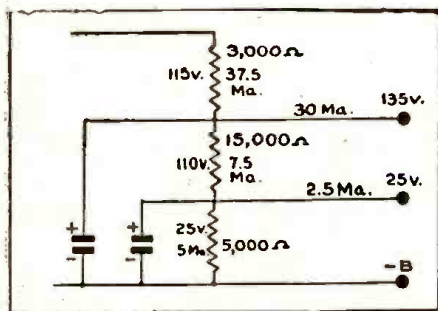

2 R.F. tubes and output pentode take 30 Ma. at 135 volts, we start as shown in the diagram.

First we allow a certain amount of bleed-current. If the transformer is large, this may be anything up to—say—20 Ma. A common rule is that the bleed-current should be at least 20% of the total drawn. As you have difficulty in obtaining large resistors, we will allow 5 Ma.

For the first bleeder section, then, we require 5 Ma. at roughly 25 volts. Ohm's Law tells us that this will require a resistor of 5,000 ohms. The next section takes us up to

the 135-volt tap of the bleeder, a distance of 110 volts. The current through this section will be the same 5 Ma. plus the 2.5 Ma. drawn by the detector, or a total of 7.5 Ma. This calls for a resistor of something more than 14,000 ohms. A 15,000-ohm resistor is close to this and is easily obtainable.

The top section of the bleeder must span the distance between the 135-volt tap and the 250-volt supply, a drop of 115 volts. The current through it is 37.5 Ma. 37.5 Ma. at 135 volts calls roughly for a 3,000-ohm resistor, by Ohm's Law.

Wattages for each of these resistors work out roughly to 4.5, 0.8 and something like 0.1 watt respectively ($115 \times .0375$; $110 \times .0075$; $25 \times .005$). Practical sizes of resistors are—allowing the usual 100% increase—10 watts, 2 watts and 1 watt. There is little use for a resistor smaller than 1 watt in a bleeder.

If it were desired to put the output pentode on a 180-volt tap, it could easily be done. In this case the 135-volt tap might draw approximately 8 Ma. and the 180-volt tap between 20 and 30, according to the pentode used. A good-sized condenser (about 8 mfd.) between each tap and ground will improve the operation of your set by preventing interstage feedback through the bleeder.

A U.H.F. RECEIVER

? Kindly publish a diagram of a 1 1/4 meter receiver. I have not found one in your magazine. Can you furnish a diagram of a compact rig, with the smallest number of tubes possible, as tubes are hard to get?—D. J. M., Vallejo, Calif.

A. The diagram shown calls for only one tube, and may be hooked up to any amplifier you have—or to your own radio—for its audio amplification.

The coils for 1 1/4 meters are: L, 2 turns of No. 18, 1/4-inch in diameter, spaced to 1/2-inch length. The antenna coil may be simply a hairpin loop in your half-wave antenna, or you may have your own preferred method of coupling.

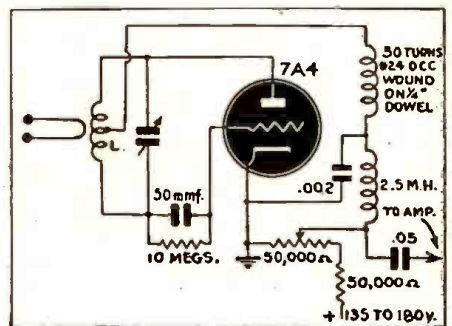

A SMALL PHONOGRAPH AMPLIFIER

? Please draw me a diagram of a small phonograph using some of the following tubes: 35A5, 35Z3, 7A8, 7B7, 7G6?—W. T. R., Chillicothe, O.

A. Three of these tubes can be made into a satisfactory phonograph amplifier. If a crystal pickup without volume control is used, omit the .05 input condenser and replace the 1 meg. resistor in the 7B7 grid circuit with a 500,000-ohm control.

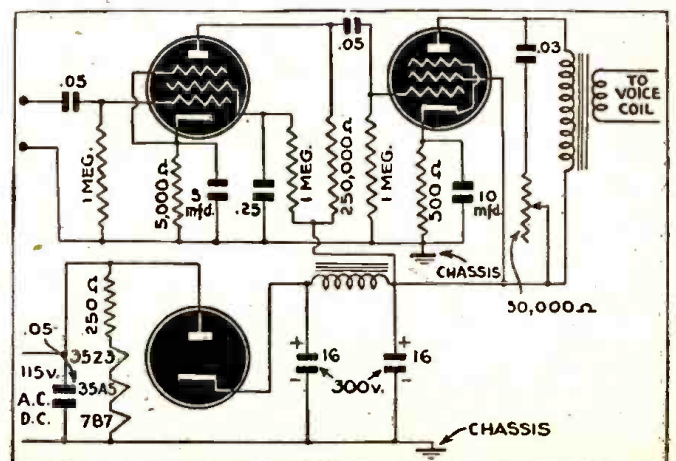

" WE'LL NEVER ATTRACT THEIR ATTENTION
AS LONG AS THEY'RE DISCUSSING THE
ECHOPHONE EC-1"



Echophone Model EC-1

(Illustrated) a compact communications receiver with every necessary feature for good reception. Covers from 550 kc. to 30 mc. on three bands. Electrical bandspread on all bands. Six tubes. Self-contained speaker. 115-125 volts AC or DC.



Echophone Radio Co., 540 N. Michigan Ave., Chicago 11, Illinois

The Radio Experimenter

TWO-TUBE TUNER AND AMPLIFIER

The regeneration is perfectly controlled with the 35 mmfd. trimmer condenser across the choke in the detector plate circuit. Regeneration assures good selectivity and sensitivity.

The number of turns on L_1 depends on the selectivity desired. For great selectivity use only half-a-dozen turns. More turns will give more volume with less selectivity, or the aerial may be connected directly to the grid end of L_2 through a small trimmer con-

denser of from 10 to 50 micromicrofarads.

The number of turns on L_2 varies with the set and the trimmer condenser used. Add or take off turns till you get the best control of regeneration. L_2 may be an old broadcast coil.

Phones may be used on this set, because with the volume control placed as it is, volume may be reduced to zero.

RAYMOND COTE,
Beauport, Quebec

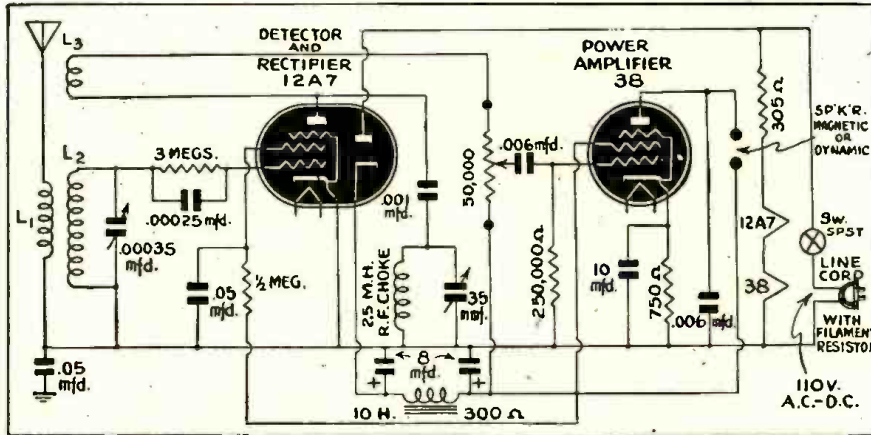

RECEIVER WITH TUNING EYE

This set gives very good results with an aerial only—no ground. The ground can be used as an aerial if you have no chance to put one up.

I have made several changes with the regeneration control. The best two are shown in the diagram.

The electron-ray tube works different with different tubes. Some are quite sensitive and flicker on code signals. If the tube is not sensitive, it can be attached to the high-volume terminal of the volume control instead of the center arm. This will give better action on stations where it is neces-

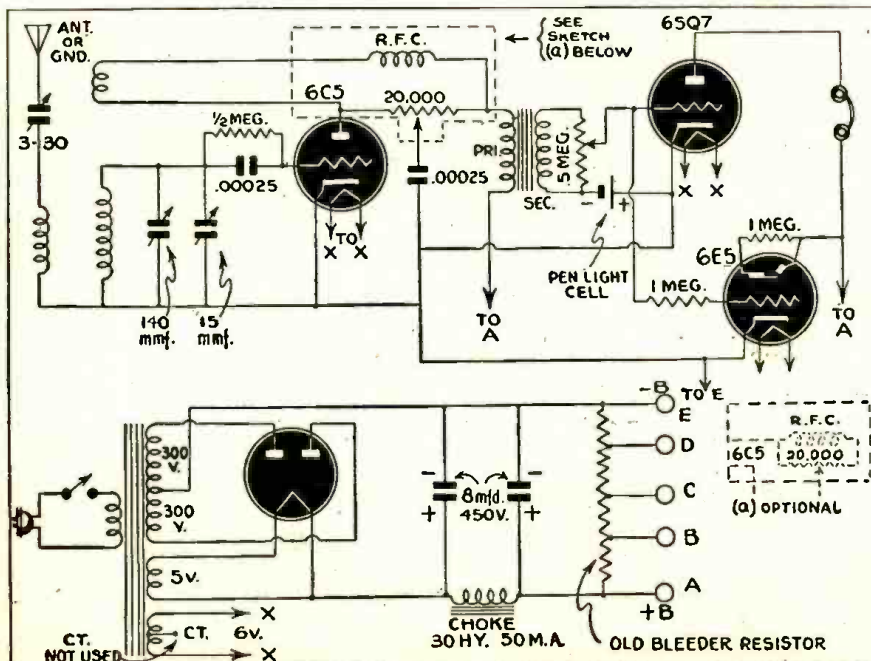

sary to turn down the volume control.

The coils may be taken from an old broadcast receiver, or wound experimentally for any wave you want to hear. Try a high "B" voltage on the detector first, then reduce it to where the signals come in best. The tapped bleeder will give you a chance to do this.

VINCENT POVILITIS,
Wilkes Barre, Penna.

I.F. AND R.F. ALIGNMENT OSCILLATOR

An extremely simple and inexpensive oscillator for I.F. and R.F. alignment is shown in the following diagram. This oscillator is suitable for any superheterodyne receiver except the early models.

An old I. F. T. was used with the primary trimmer (A) disconnected.

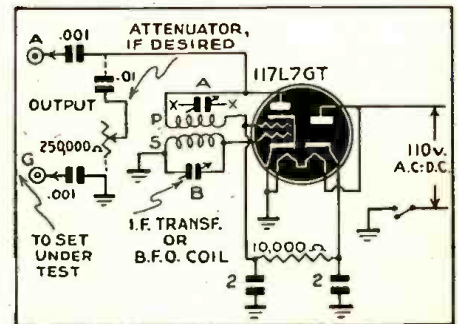

In my own oscillator I used a 12A7 tube (which I had on hand) with a 330-ohm line cord resistor.

THOMAS E. DADSON
Detroit, Mich.

TINY RECEIVER

This set uses one of the RCA type "Miniature" tubes. It can be built in a very small box and works quite well.

It is powered by four penlight cells for the "B" voltage, and one penlight cell for the "A" voltage. The loop can be wound around the box and the correct number of turns be determined by experiment. An approximate number is given, namely, 30 turns. (See diagram.)

It is wound in a continuous process and tapped at ten turns for the tickler.

In the original, an extension rod was soldered to a mica trimmer condenser and was used for the regeneration control.

RAYMOND MEGIRIAN,
Jackson Heights, N. Y.

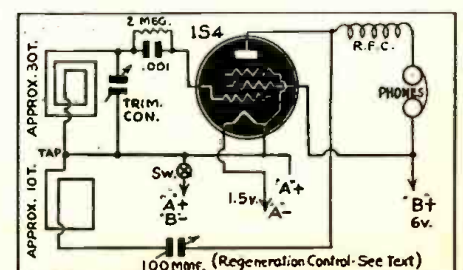

SPRAGUE TRADING POST



A FREE Buy-Exchange-Sell Service for Radio Men

WANTED—5-7" foundation meter, test eqpt., Rider's manuals, 35Z5, 50L6, 117L7, and 12SA7 tubes; galvanometer, treasure finder plans, small radios, magnet wire, etc. What have you? Ponce de Leon Radio Service, 463 Poncedeleon Ave., Atlanta, Ga.

FOR SALE—Two T.C.-500-C Hammarlund transmitting condensers @ \$2 ea.; two 70 ohm 150 mil. cased filter chokes @ \$2 ea.; one new 500 mil. 70 ohm, 20 henry cased filter choke, \$4; one Jewell 0-200 mil. D.C. 3/4" meter, \$3; one Shure 35N microphone double button carbon, best offer takes it. All A-1 condition. G. C. Burchfield Benton City, Mo.

WANTED—Will buy Supreme audolyzer #562 with instructions. Home Radio Service, Plymouth, Wisc. (Box 45).

WANTED—A ten- to 30-watt amplifier in good condition. State price & details. J. Ike, 28-11-C Minidoka, Hunt, Idaho.

WANTED—Allied's 2N279 oscillator coil; 1N060 5-section filter condenser; and 1N058 400-ohms line cord. These parts needed for Knight 3-tube phono oscillator. C. Goodman, 4415 Esplanade Ave., Montreal, Que., Canada.

WILL SWAP—Offer cash and my Howard 460X and speaker for a late model Hallcrafters SX-28. Also want crystal pickup & Motor; and Hallcrafters HT-7 frequency meter. William Matchett, P. O. Box 576, Arcata, Calif.

WANTED AT ONCE—V-O-M in good condition. Give age, cond., and price. Neil Skinner, P. O. Box 1136, Woodland, Wash.

FOR SALE—112 mc. transmitter, modulator complete except for 6J7, 6FGT, and 6AG tubes. Separate power supply is needed with an output of up to 100 watts. Will sell for cash or trade for pocket V-O-M. Teddy Powell, Box 13, Hobe Sound, Fla.

EQUIPMENT FOR SALE—One RCA #155 3" scope; RCA 154 B.F.O.; RCA #153 signal generator; Superior channel analyzer. Best offer for each piece takes it. Also have complete set Rider's manuals like new 1 to 5 abridged, \$105, several amplifiers and meters, and many tubes and parts. Write: J. W. Hammond, 631 N. E. 10th St., Fort Lauderdale, Fla.

FOR SALE OR TRADE—12" Federal recorder; 6-tube 6-volt laydown mental type Air Castle radio; 5/16" Bakelite 18" x 21 1/2"; one W-E 242B tube; one De Forest 511-E tube; 250-210-281 tubes; 18" Jensen L-18 speaker; Mecco xmitting key with navy knob; Fox horn unit and Fox 6-volt double horn unit exciter. Want record changer, inverse trumpets, or heavy-duty Jefferson or Thordarson P.A. amplifiers or kits. Maxwell M. Snavely, 1014 Cedar St., Elkhart, Ind.

WILL TRADE—Supreme automatic tube tester #385 (multimeter). Want Rider's manuals or will sell for cash. Raymond Papineau, 725 N. Rockhill, Alliance, Ohio.

WANTED—One 2 amp. Tungar battery charging bulb or a complete 5 amp. battery charger, or something similar. Cicero La Hatte, Jr., 1021 National St., Vicksburg, Miss.

WANTED—Alden universal adapters and extensions, items 7A, 944UT, 955UT, 977UT, 977UTA, 988UT, 7B, 9DL cable, 7C-9DL dual connector cord; 7D112D plug. B. A. Crossno, Route 2, Paris, Ark.

WANTED—Shure "Transcription Type" X'tal pick-up or Shure Zephyr pick-up, complete with shielded cord. State price & cond. B. Pidruczny, R. R. #1, Aldergrove, B. C., Canada.

FOR SALE OR TRADE—One new Kodak advance enlarger. Want signal generator, communications receiver, or other radio supplies. Ruhard A. Sutter, Salisbury, Mo.

V-O-M WANTED—Also tube tester. Will consider comb. tube & set checker. State age, cond., price, and model. A. R. Green, 3921 Hampshire Blvd., Fort Worth, Texas.

TUBES FOR SALE—We offer a limited number of the following @ 40% off list. Cash with order or C.O.D.: 1A4; 1A6; 1B4; 1B5; 1D7; 1E7; 1F4; 1F6; 1F7; 1H6; 2A5; 2B7; 19, 6A4; 46; and 49. Hud Appliance & Supply Co., Crown Point, Ind.

FOR SALE—110 V. 250-watt AC Powerack. Want to buy RCA Volt-onmyst or other good vac. tube voltmeter. Killian Radio Service, Lincoln & Mulberry Sts., Utica, N. Y.

FOR SALE—One Clough-Brengle #81-A frequency modulator; one RCA 151 cathode ray oscillograph, practically new. Will consider trading for good vacuum tube V-O-M or other test eqpt. Charles Ledford, 12 1/2 Grand St., Glens Falls, N. Y.

FOR SALE—1/2 KW. transmitter fone and C-W for 80, 40, and 20 meters. Complete in 6' gray rack. Fully metered. Also plenty of new filter, by-pass, and mica condensers, 10% off list. Make offer for Xmitter, and write for condensers wanted. Want to buy Precision 920 tube tester. Name price. H. D. Young, Chief Engineer, c/o Radio Station KDRO, Sedalia, Mo.

WANTED—For engineering & recording work, one Weston voltmeter (rectifier type), range 0-5 volts AC to be used as output meter. Model 301. Hyman Mandel, 315 Kensington Ave., Westmount, Quebec, Canada.

WANTED—Recorder complete or recording turntable and mechanism less amplifier. Magnetic head type preferred. Also need 12SK; 12SA7; 12SQ7; 35Z5; and 50L6 tubes. Ward Lantis, 1217 1/2 So. Washington St., Marion, Ind.

CASH FOR TUBES—Want 25L6; 6U5/6G5; 6J7; and 200 ohm ballast tube. G. Jacobs, 936 E. 15th St., Brooklyn, N. Y.

WANTED—Amateur television eqpt. such as receiver & transmitter complete with all tubes; television iconoscope tube (2" will do). Receiver may use two or three inch tube. Baptiste Radio Services & Main Eng., P. O. Box 114, Howard, Rhode Island.

FOR SALE—Two brand new Eimac 150-T's @ \$24.50 ea.; also RCA signal generator #TMV 97-C @ \$15; also Thordarson input & output class B modulation transformers for 10's, 809's, TZ20's. @ \$7.50. Fred Craven, 2216 S. 7th St., Philadelphia 48, Pa.

WANTED—Coils for National A.C. S.W.-3, range 13.5 meters to 550 meters. Cpl Joseph S. Novick, 31st Air Base Squadron, March Field, Calif.

WANTED FOR CASH—Jackson signal analyzer #660; Supreme #562 audolyzer, or other std. signal trader. All letters answered. McCurdy's Radio Shop, 2263 So. 6th St., Klamath Falls, Ore.

WANTED—The following tubes: 12SA7GT; 12A8GT; 12SQ7GT; 12A7GT; 12SK7GT; 12Q7GT; 35Z-5GT; 25Z5; 25L6; 6A8; 6F6; 6Q7; 6D6; 6X5; 6H6; 2A5; 26; 38; 45; 47; 56; 68; 59; 5Y3; 50L6GT; 70L6GT. Name price and quantity available. Cadillac Sound Eqpt. Co., 3547 Beniteau Ave., Detroit 14, Mich.

FOR SALE—One RCA 913 cathode ray oscilloscope tube. New—never used. \$4. David J. Krassen, 3115 W. Norris St., Philadelphia 21, Pa.

FOR SALE—Four Weston meters: DC301 0-750-v, 4 scales; AC476 0-750, 4 scales; DC301 0-25 mills; DC354 60-0-60 amps.; also Dayrad Type 50 output meter control and rectifier built in; Genemotor 300-v, 100-mill.; Philco 027 VTVM; Clough-Brengle 110 signal generator; adapters for 50L6 or 35L6 to 35A5 and 35Z5 to 35Z3, also others. Want 25L6, 6SK7, and 6SQ7 tubes; 200-ohm 20-watt resistors, 12-gauge shotgun shells; Hickok #510 or 530 or Jackson 636 or 637. C. F. Carrick, 420 Sherman St., Couer D'Alene, Idaho.

MANUALS FOR SALE—Rider's Vols. 6-7-8-9-10-11-12. All 7 books in good condition for \$55 cash. Fix-It Stop, 1555 S. Kentucky Ave., Evansville, Ind.

WANTED—Hickok 510x set and tube tester; Hickok 188x signal generator; Aerovox L/C checker #95. Will pay cash or part swap. What do you need? I have three Hickok 3" meters as follows: O-15 D-C V; O-90 D-C V, zero at center of scale; O-3/15/150 A-C V. Send list of what you need. F. V. Dillion, 1200 N. Olive Drive, Hollywood 46, Calif.

WANTED AT ONCE—Oscilloscope and RCA model 165 volt ohmyst. A. B. Eatherly, 1504 Bernard St., Nashville, Tenn.

URGENTLY NEEDED—Late model tube checker; good signal generator; oscilloscope with tube. Barker Radio Service, 67 Mass St., Westerly, Rhode Island.

CASH WAITING FOR YOUR UNUSED PARTS AND EQUIPMENT



Going into the Army or Navy? Giving up your service work for a war job? Or, even if you have remained in servicing work and have unused parts and equipment lying around, you can still render a patriotic service by advertising these for sale through the Sprague Trading Post. We'll gladly run your ad free.

Radio equipment of all types is badly needed today—and the Trading Post will help you dispose of it quickly. It is a golden opportunity to do your bit in keeping radios working on the home front and, at the same time, turn unused materials into cash, and avoid the possibility of obsolescence when the war is won and new, up-to-the-minute equipment is again available.

Your Ad Run Free!

Send in your ad today. "Equipment for Sale" and "Equipment Wanted" ads of an emergency nature will receive first attention. Sprague reserves the right to eliminate any ads which do not fit in with the spirit of this special wartime advertising service. Different

Trading Post ads appear regularly in Radio Retailing-Today, Radio Service-Dealer, Service, Radio News, and Radio-Craft. Please do not specify any certain magazine for your ad. We'll run it in the first available issue that is going to press.

Dept. RC 312 SPRAGUE PRODUCTS CO., North Adams, Mass.

SPRAGUE CONDENSERS KOOLOHM RESISTORS



Obviously, Sprague cannot assume any responsibility, or guarantee goods, services, etc., which might be exchanged through the above advertisements

RADIO KINKS

HANDY POINT-TO-POINT CHECKER

A simple point-to-point checker can easily be constructed with the analyzer plug from an old analyzer, five sockets, eight toggle switches and a number of pin jacks. The whole thing can easily be mounted on an 8 x 10-inch bakelite, masonite or metal panel. Mine was mounted on plywood varnished with insulating varnish.

The hookup is simple. Corresponding prongs are attached together on all the

When the analyzer plug is plugged into a socket, and the tube plugged into the point-to-point tester, the voltage on any one of the elements can readily be checked. This check may be made to ground, or between any two elements. By plugging a milliammeter across any switch and opening the switch, the current may be measured.

This type of point-to-point checker is especially useful in studying the action of power output tubes. By watching a milliammeter in the plate circuit, as the volume control is varied, wrong bias may be discovered and the grid voltage adjusted to the best point (i.e., that point which causes a minimum change—or no change—in plate current when loud signals strike the grid). It is also very useful in checking certain sockets in some midjets where it may be difficult to get at the tube prongs from below the chassis, and may be used for certain tests without removing the chassis from the cabinet.

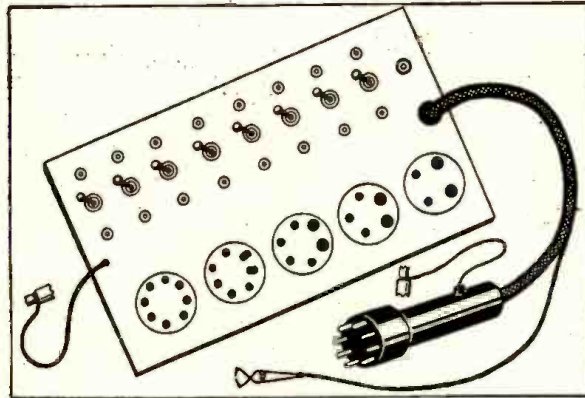

sockets, then a lead from each is run to one of the pin jacks in the inside row, through the switch and past the outside pin jack of the same row. The corresponding lead of the analyzer cable is attached to the same outside pin jack.

It must be noted that in many circuits—notably in the I.F. stages—strong oscillation takes place when the tube is operated in the checker socket. The result is that normal voltages are often, and currents almost always, upset. This limitation must be taken account of, or the serviceman is likely to deceive himself.

In my instrument, a seven-prong plug was used, with adapters for the four-, five-, six- and eight-prong sockets. The cable-shield acted as ground lead, and was brought out to the single pin jack at the bottom of the double row. The lead was also taken to the No. 1 prong of the 8-prong tube, the normal filament leads of the other tubes being connected to prongs 2 and 7. This of course would not be necessary with an 8-lead cable.

"BED FELLOW" RADIO

In the following hook-up, a 117L7 tube plus a few used parts makes possible the construction of a compact receiver that can be hooked over the head of a bed. A short lead terminated with an alligator clip that can be attached to the bed springs serves as an aerial.

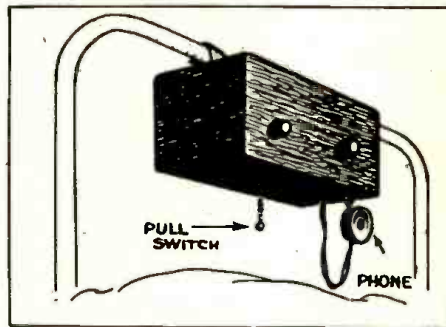

A canopy pull chain switch is mounted in the bottom of the cabinet as it is more convenient to operate while lying down than a turn or toggle type. The switch can be taken from an old lighting fixture or bought at an electrical supply store.

The coil is an R.F. coil from an old receiver. The primary is used as a tickler. If only high impedance primary coils are available, the primary should be removed and 15 to 20 turns wound instead.

The base of the headphone can be drilled and a small screw eye inserted. The screw eye will cut its own thread if the hole is slightly smaller than the threaded portion. A cup hook is inserted on the under side of the cabinet so that the head phone may be hung up when not in use.

The cabinet can be fashioned from a small box or built of plywood with a masonite panel.

E. E. YOUNGKIN,
Altoona, Pa.

QUICK BATTERY HOOKUP

Many times one desires to use flashlight cells without having to solder wires to the terminals of the batteries. One can avoid this by using grid caps for the positive terminals and a bare wire slipped under the cardboard cover of the battery for the negative terminals.

DON LIM
San Francisco, Calif.

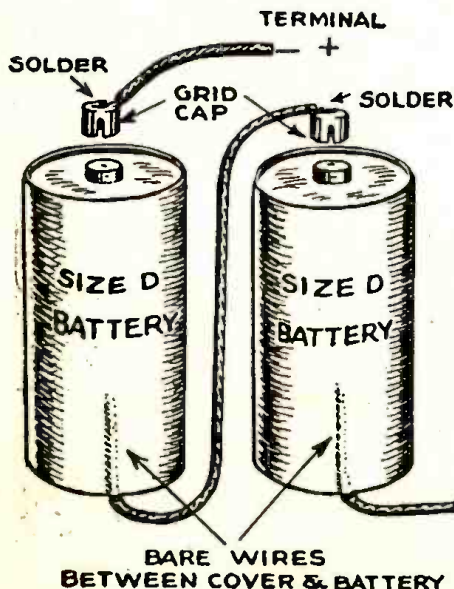

ERIC LESLIE,
New York, N. Y.

A GOOD KINK

For beginners who want to learn the code, but who own broadcast receivers without a B.F.O.

There are two simple ways to get regeneration and enable the set to pick up C.W. signals. One way is to wrap a piece of thin wire around the plate of the first I.F. tube and then wrap it around the grid of the same stage. Needless to say the wire must be insulated. Experimenting will indicate just the right amount of wire to use.

Another method is to disconnect the screen bypass condenser of the first I.F. stage. Either method will cause the tube to oscillate, thereby beating with C.W. signals and making them audible.

JOHN OLIVEIRA,
Former Chief Engineer
KHUB, Watsonville, Cal.

REVERSING SWITCH

This is a sketch of a simple set-up for use with a standard test instrument. The idea is to give a quick reversing means to the test leads for purpose of testing condensers. It also helps in testing D.C. voltages and by means of the two pairs of leads connected at all times, gives a choice of needle-point leads or alligator clips.

JAMES M. MACGOWAN,
Minneapolis, Minn.

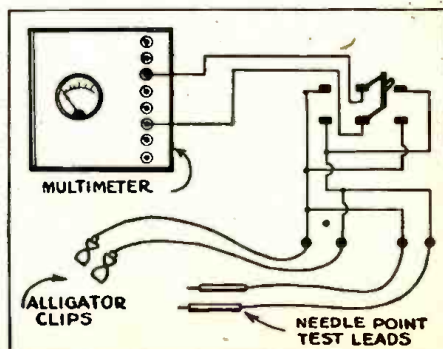

ANSWER

To an Engineer's Prayer

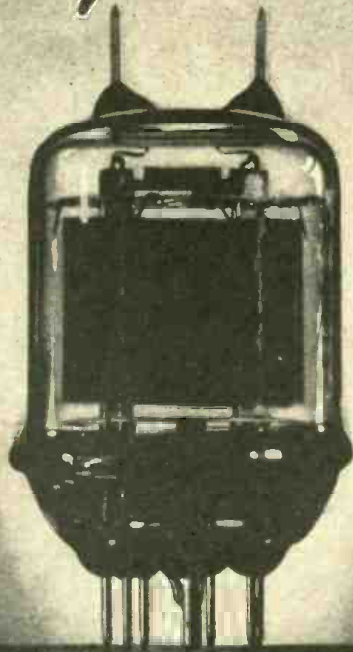

WHEN WAR began, among products high on the "critically needed" list were N. U. power tubes. To operate thousands of field and ship transmitters, these tubes were needed in quantities which called for vastly increased facilities *plus some entirely new thinking along mass production lines.*

With thoroughness that could not miss, National Union engineers went to work on this assignment. Soon they not only had the increased volume required . . . but in addition had found the answer which many a tube engineer and production man had long sought, even prayed for . . .

the Tube Industry's first automatic exhaust and sealing machines to operate successfully with this type of tube.

Such resourcefulness and engineering capacity have played no small part in making National Union one of the Tube Industry's largest producers of war goods. You will want to remember this achievement when shaping up your post-war plans, and when counsel in electronic applications is needed. *Count on National Union.*

National Union Radio Corporation, Newark, N. J.
Factories at Newark, N. J.; Maplewood, N. J.
Lansdale, Penna.; Robesonia, Penna.



NATIONAL UNION

RADIO AND ELECTRONIC TUBES

Transmitting, Cathode Ray, Receiving, Special Purpose Tubes • Condensers • Volume Controls • Photo Electric Cells • Panel Lamps • Flashlight Bulbs

"We'll help you
MAKE 'EM LAST"

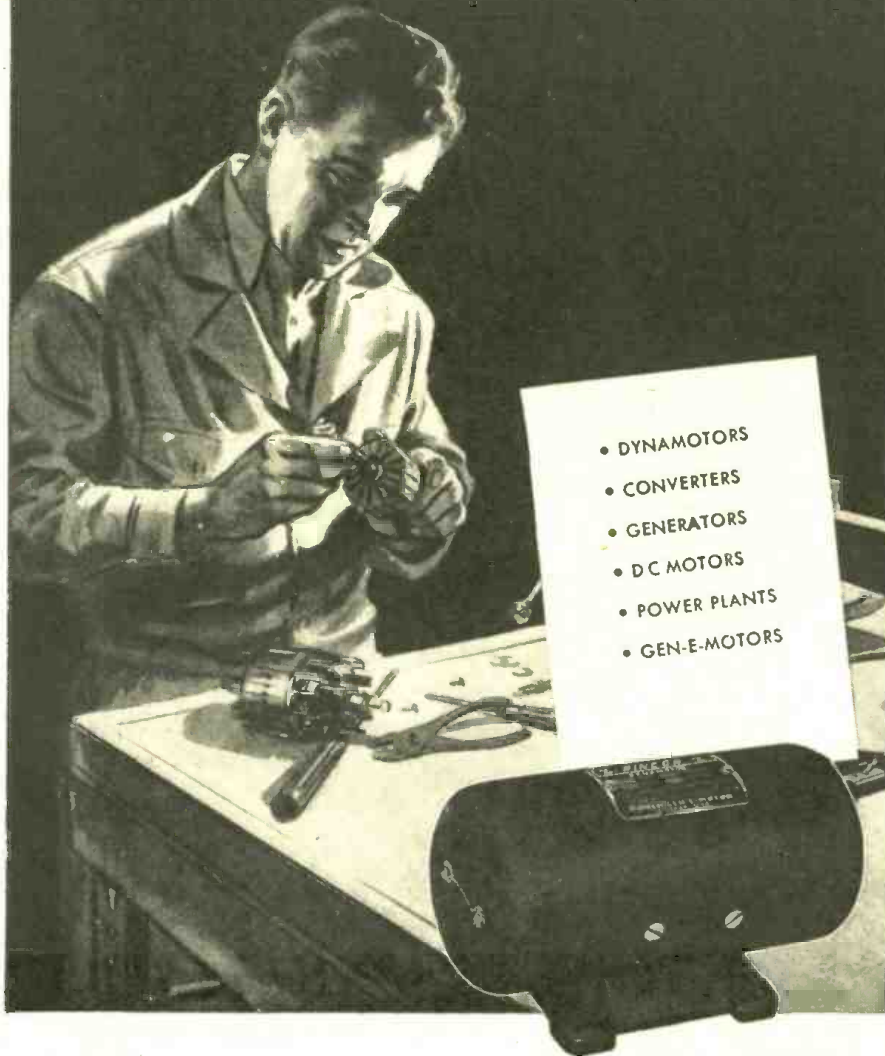

Jim and His Fellow Workers are ON THE JOB!

They've pledged themselves to make your present Pincor equipment last for the duration. That's a big job but these men can do it. They *must* do it to insure that *all* new Pincor Products find their way to the fighting front. Pincor's number one job right now is to supply fighting men with tools of battle. Jim and men like him make it possible for us to do this on an all-out war production basis. He'll take care of the home front while our plants supply the fighting front. Bring your problems to him—but please bring only PINCOR problems: there just aren't enough hours in the day to take care of any others.

POPULAR ELECTRONICS

(Continued from page 137)

center of the chamber and mounted directly between the halves of the severed "pill box" there is a hot metallic filament which produces deuterons from the heavy hydrogen by direct electronic bombardment. Whirled around and around, the deuterons, upon reaching the limit of the arc they can describe, are teased out of the chamber by an electrostatically charged "deflector electrode." This guides the deuteron to a small, thin metal window placed in the disintegration or bombardment chamber. Here the deuteron enters to strike the element under treatment.

Smashing into the atoms within the chamber, the deuterons, protons or neutrons used will, in a small number of cases out of a large number of possibilities, strike the nuclei of a few of the atoms. When this happens, a violent form of interatomic electrical congestion develops with consequent expulsion. The intruder (deuteron, proton or neutron) when it enters an atom of the solid or gaseous element within the disintegration chamber, produces an intolerable electrical condition that simply cannot long endure. There results a preponderance of electrical charges that instantly calls for a re-distribution of inter-atomic energy and the particles involved immediately re-arrange themselves. There emerges as a result of this re-arrangement an atom quite different from that which happened to be the bull's-eye for the bombardment particle. Reduced to its simplest term, this is the mechanism of transmutation, effected through the use of the cyclotron, ultra-modern engine of destruction.

To date, the atoms of some eighty odd elements have been torn asunder by one form of bombardment mechanism or another. The cyclotron has an outstanding record because, through certain refinements and modifications, it has become the most prolific source of neutrons. The neutron, it will be recalled, has the mass of a proton but it has zero electric charge. Strange, too, it is that an electrically neither-here-nor-there particle should put in an appearance in a world so definitely and completely divided between positive and negative things. This indifferent attitude of the neutron makes of it a very useful projectile to aim at atoms, and it is therefore in great demand for this purpose.

As a source of neutrons, the physicist used, until the advent of the cyclotron, a mixture of the light element beryllium and radium. Brought together, the alpha particles shot off by the radium will immediately bombard the beryllium atoms, disintegrate a large number of them and bring about the formation of carbon and free neutrons. When beryllium is bombarded with deuterons in the cyclotron, the result is boron and neutrons. When the cyclotron is set to work bombarding beryllium with deuterons, it does its job so efficiently that in order to match it, a mixture of beryllium and 100 kilograms of radium would have to be used. Far from surprising, then, is the steady increase in the use of the relatively inexpensive cyclotron mechanism in the investigation of our atomic world.

George S. Turner, assistant chief of the FCC's Field Division since 1940, has been named to take the place left vacant by the veteran William D. Terrell, who recently retired after 40 years in radio and communications service.



PIONEER GEN-E-MOTOR

CHICAGO, ILLINOIS • EXPORT ADDRESS:
 25 WARREN STREET, NEW YORK CITY

BUY WAR BONDS

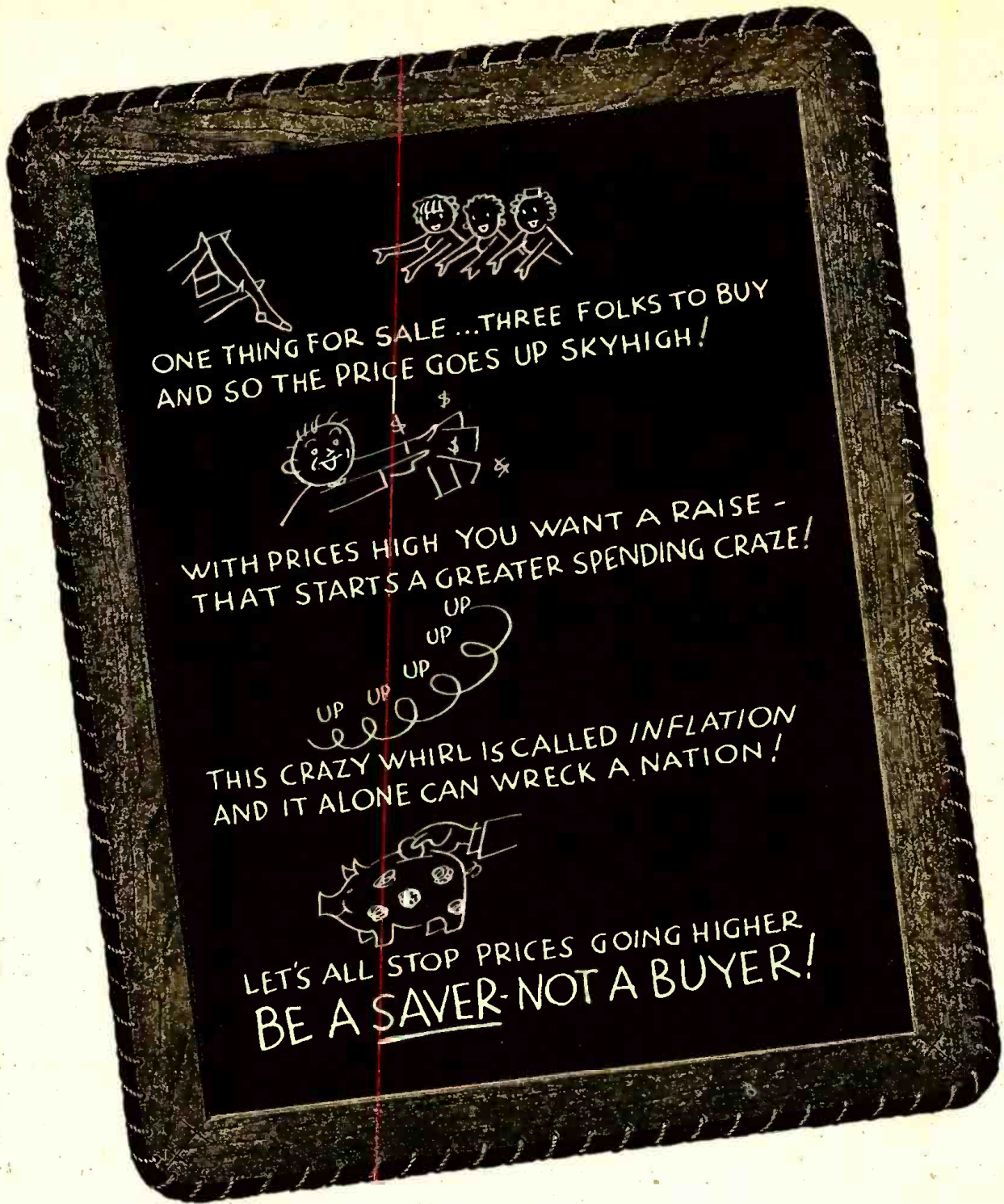

Seven things you should do:

<p>1. Buy only what you really need</p>	<p>2. Pay no more than ceiling prices... buy rationed goods <u>only</u> with stamps</p>	<p>3. Pay off old debts and avoid making new ones</p>	<p>4. Support higher taxes ... pay them willingly</p>	<p>5. Provide for the future with adequate life insurance and savings</p>	<p>6. Don't ask more money for goods you sell or work you do</p>	<p>7. Buy all the War Bonds you can afford - and keep them</p>
---	---	---	---	---	--	--

Keep prices down...use it up, wear it out, make it do, or do without

This advertisement, prepared by the War Advertising Council, is contributed by this magazine in cooperation with the Magazine Publishers of America.

EASY TO READ



E
MVT
OPZ
BCE

EASY, error-free reading is one of the many features of the new General Electric line of SERVICE TESTING EQUIPMENT. Designed in the famous G-E electronic laboratories, this line provides an extensive choice of sturdy, portable, compact maintenance and testing apparatus for radio service men, service dealers and others.

For testing radio electronic circuits and component parts, these units include: G-E unimeters, tube checkers, audio oscillators, oscilloscopes, condenser resistance bridges, signal generators and other utility test instruments.

G-E testing equipment is now in production primarily for the Armed Forces. But these stable, shock-resistant units may be purchased on a priority if you are engaged in war work. When peace comes, the full line will again be available to everybody... *Electronics Department, General Electric, Schenectady, New York.*

FREE CATALOG

**ELECTRONICS DEPARTMENT
GENERAL ELECTRIC CO.
Schenectady, N. Y.**

Please send, without obligation to me, the General Electric Testing Instrument Catalog, R-1 (loose-leaf), for my information and files.

Name _____
Address _____
Company _____

GENERAL ELECTRIC
Electronic Measuring Instruments

TRANSMITTERS FOR FM

(Continued from page 149)

The audio voltage is still applied through an integrator network I to the control grids of the modulators 180° out of phase. The plates of V1 and V2 are still connected in parallel and directly connected to the tank circuit T2 which acts as the mixing tank circuit. With no audio applied to the control grids two R-F currents are present in T2 90° out of phase. These R-F currents are the plate currents of V1 and V2 respectively. The equal grid excitation on V1 and V2 results in the R-F currents in T2 being equal. Adding these two sine currents vectorially and sinusoidally results in a new R-F current which is 45° out of phase with that of V1 and V2, and proportional in amplitude to the addition of V1 and V2.

This can be readily seen in Fig. 5. At (a) we have the two plate currents flowing into T2 which are 90° out of phase with A leading B; at (b) is addition of the two R-F currents 90° out of phase and of equal magnitudes, the resultant C can be seen to be 45° out of phase with A and B; in (c) the vector representation is given which shows the resultant 45° phase angle more clearly. As long as there isn't any modulation the resultant R-F current in T2 is 45° out of phase with A and B. This should make it perfectly conceivable that the maximum phase shift capability in this system is only 45° in one direction as a contrast to the original system.

As modulation takes place the resultant effects are shown in Fig. 6 and Fig. 7. In Fig. 6 it is assumed that the control grid of V1 is becoming less negative, and the control grid of V2 more negative due to the audio voltage from the microphone; therefore, the R-F plate current of V1 will increase and that of V2 will decrease. At 6(a) there is no modulation and the resultant C is 45° out of phase with A and B; at (b) A is increasing with modulation and B is decreasing and C shifts by θ toward A. At (c) A has increased to maximum and the phase shift θ has reached its maximum angle. At (d) the amplitude of A is decreasing again and θ has gone back to the same angle as in (b). At (e) the modulation is at zero again and the resultant C is back at its original 45° angle with respect to A and B. The maximum shift in this direction would be 45° and would be accomplished when A went to maximum and B would be zero.

In Fig. 7 it is assumed that B is increasing and A is decreasing. At (a) there is no modulation and C is 45° out of phase with A and B; at (b) B is increasing and the resultant C is advancing toward B by the angle θ . At (c) B has increased to maximum and A is decreasing and that of V2 will decrease. At (d) B has started to decrease and the phase angle θ is the same as (b); at (e) the modulation is at zero and C is back to its original 45° angle with respect to A and B. For a complete 45° shift in phase in this direction would be accomplished when B went to maximum and A to zero. Studying Figs. 6 and 7 closely it can be seen that in Fig. 6 the frequency of the resultant C increases above the resting value and in Fig. 7 the frequency of C decreases below the resting value; therefore, the phase shift produces a corresponding frequency shift. It can also be seen that the resultant C is amplitude modulated as well, but the class "C" stages following the modulating system will iron out these variations. This modified version of the Armstrong method gives us a more fool proof system by eliminating the mixer stage tuned circuit, and thereby increasing the simplicity of the system.

At (a) there is no modulation and the resultant C is 45° out of phase with A and B; at (b) B is increasing and the resultant C is advancing toward B by the angle θ . At (c) B has increased to maximum and A is decreasing and that of V2 will decrease. At (d) B has started to decrease and the phase angle θ is the same as (b); at (e) the modulation is at zero and C is back to its original 45° angle with respect to A and B. For a complete 45° shift in phase in this direction would be accomplished when B went to maximum and A to zero. Studying Figs. 6 and 7 closely it can be seen that in Fig. 6 the frequency of the resultant C increases above the resting value and in Fig. 7 the frequency of C decreases below the resting value; therefore, the phase shift produces a corresponding frequency shift. It can also be seen that the resultant C is amplitude modulated as well, but the class "C" stages following the modulating system will iron out these variations. This modified version of the Armstrong method gives us a more fool proof system by eliminating the mixer stage tuned circuit, and thereby increasing the simplicity of the system.

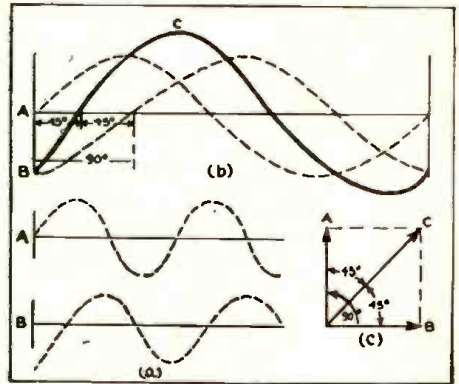

Fig. 5. Effect of adding two out-of-phase currents.

imum and A decreased to minimum and the phase shift θ is maximum in the opposite

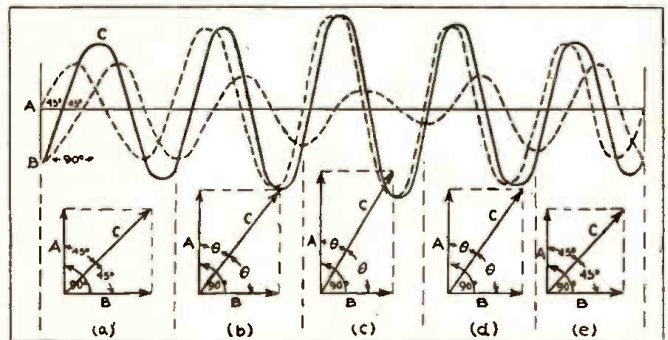

Fig. 6. Advance in phase on one side of audio wave.

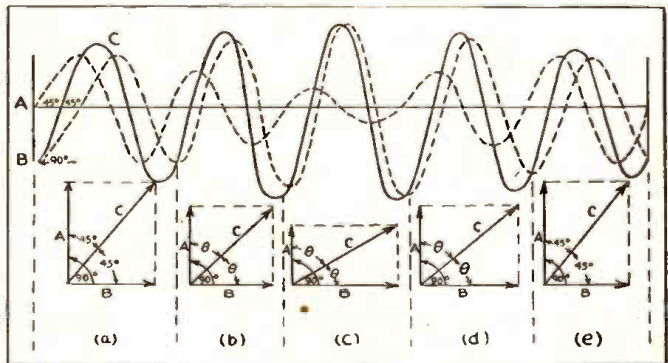

Fig. 7. Phase retardation on other half of the wave.

direction. At (d) B has started to decrease and the phase angle θ is the same as (b); at (e) the modulation is at zero and C is back to its original 45° angle with respect to A and B. For a complete 45° shift in phase in this direction would be accomplished when B went to maximum and A to zero. Studying Figs. 6 and 7 closely it can be seen that in Fig. 6 the frequency of the resultant C increases above the resting value and in Fig. 7 the frequency of C decreases below the resting value; therefore, the phase shift produces a corresponding frequency shift. It can also be seen that the resultant C is amplitude modulated as well, but the class "C" stages following the modulating system will iron out these variations. This modified version of the Armstrong method gives us a more fool proof system by eliminating the mixer stage tuned circuit, and thereby increasing the simplicity of the system.

THE LISTENING POST

(Continued from page 161)

Mc.	Call	Location and Schedule	Mc.	Call	Location and Schedule	Mc.	Call	Location and Schedule
9.615	TIPG	SAN JOSE, COSTA RICA; "La Voz de la Victor."			10:15 pm to 3:45 am; 11:15 am to 2:15 pm; Australian beam, 4 to 9 am.			(Japanese) 3:30 am; "New Caledonia beam (French) 4:30 am; Allied Forces in South Pacific beam (English) 5:30 am.
9.620	—	"VOICE OF FRANCE"; not heard in several weeks.	9.897	WKRX	NEW YORK CITY; North European beam, 6 to 8:45 pm.	11.720	CJRX	WINNIPEG, CANADA; 12 noon to 4:30 pm.
9.62	—	VICHY, FRANCE; North American beam, 9:45 pm.	9.935	—	"RADIO MEDITERRANEAN"; heard Sundays, 1:58 to 2:30 pm.	11.72	PRL8	RIO DE JANEIRO, BRAZIL; "Radio Nacional"; nightly beamed to North America; 10 to 11 pm.
9.626	ZRL	CAPE TOWN, SOUTH AFRICA; not heard recently.	9.935	SVM	ATHENS, GREECE.	11.72	HSP5	THAILAND; not heard in recent weeks.
9.630	2RO3	ROME, ITALY; off since September 8th.	9.970	HCJB	QUITO, ECUADOR; 7 and 10 pm in English.	11.725	JVW3	TOKYO, JAPAN; 9 am to 12:30 pm.
9.637	—	"GUSTAV SIEGFRIED EINS"; not heard recently.	9.98	—	FRENCH EQUATORIAL AFRICA; "Radio Club"; not heard in several weeks.	11.730	CBNY	HAVANA, CUBA.
9.64	KZRH	MANILA, PHILIPPINES; not heard in several weeks.	10.005	—	"VOICE OF FREE ARABS"; not heard in several weeks.	11.730	WRUL	BOSTON, MASSACHUSETTS; Caribbean beam, 6:15 to 7:15 pm; Central America beam, 7:30 pm to 2 am.
9.645	—	"GUSTAV SIEGFRIED EINS"; not heard recently.	10.050	XBHX	MEXICO CITY, MEXICO; 8 am to 8 pm daily.	11.730	WRUW	BOSTON, MASSACHUSETTS; North African beam, 8 to 10 am; European beam, 2:30 to 6 pm.
9.645	LLH	OSLO, NORWAY; not heard in several weeks.	10.055	SUV	CAIRO, EGYPT; afternoons; irregular.	11.74	COCX	HAVANA, CUBA; day and night transmissions.
9.650	WCRC	NEW YORK CITY; European beam, 12:15 to 2 am.	10.250	XGAP	PEIPING, CHINA; not heard in several weeks.	11.74	HBJ	VATICAN CITY; not being heard at present time.
9.650	WCDA	NEW YORK CITY; European beam, 5 to 7 pm.	10.380	—	"STATION DEBUNK"; STATION OF THE ALL FREE; not heard for several weeks.	11.74	HP5Q	PANAMA CITY, PANAMA; not heard in recent weeks.
9.670	WRCA	NEW YORK CITY; Brazilian beam, 8 to 11:30 pm.	10.445	—	MOSCOW, U.S.S.R.; not heard in several weeks.	11.750	GSD	LONDON, ENGLAND.
9.670	WNBI	NEW YORK CITY; European beam, 12:15 to 2 am; 4:30 to 5:15 pm.	10.540	DZD	BERLIN, GERMANY; 5:50 to 8 pm to North America.	11.760	TGWA	GUATEMALA CITY, GUATEMALA; off the air now.
9.67	COCQ	HAVANA, CUBA; not heard in several weeks.	10.620	CEC	CHILE; not heard recently.	11.77	DJD	BERLIN, GERMANY; North American beam; not heard recently.
9.685	TGWA	GUATEMALA CITY, GUATEMALA; 9:55 pm to 12:45 am daily.	10.610	ZIK2	BELIZE, BRITISH HONDURAS; not heard recently.	11.775	—	SAIGON, INDO CHINA; 10 to 11:30 am.
9.690	GRX	LONDON, ENGLAND; North America beam, 10:45 pm to 12:45 am; now being used by the Dutch government in exile.	10.620	KES3	SAN FRANCISCO, CALIFORNIA; N. E. I.-Oriental beam, 1 to 6 am.	11.775	MTCY	HSINKING, MANCHURIA.
9.69	LRA1	BUENOS AIRES, ARGENTINA; Fridays only, 5 to 5:30 pm.	10.840	KWV	SAN FRANCISCO, CALIFORNIA; Australian beam, 2 to 4:45 am; South American beam, 5 to 7 am.	11.78	GVU	LONDON, ENGLAND; North American beam, 6:30 to 7 pm.
9.700	WRUW	BOSTON, MASSACHUSETTS; Caribbean beam, 6:15 to 7:15 pm.	11.000	PLP	BANDOENG, JAVA NETHERLANDS INDIES.	11.790	HP5G	PANAMA CITY, PANAMA; 9:45 to 7 pm.
9.700	WRUS	BOSTON, MASSACHUSETTS; Mexican beam, 7:30 pm to 2 am; North African beam, 2:15 to 6 am.	11.145	WRUA	BOSTON, MASSACHUSETTS; North African beam, 4:15 to 5:30 pm.	11.79	KGEL	SAN FRANCISCO, CALIFORNIA; South American beam, 5 pm to 12:45 am.
9.7	—	FORT DE FRANCE, MARTINIQUE.	11.37	—	"CROATIAN FREEDOM STATION"; 2:30 to 2:40 pm.	11.800	H13X	TRUJILLO CITY, DOMINICAN REPUBLIC; testing at 12:15 pm; afternoons.
9.720	XGOA	CHUNGKING, CHINA; not heard in several weeks.	11.470	—	"VOICE OF FREE INDIA"; 10 am to 12:05 pm.	11.800	DJZ	BERLIN, GERMANY.
9.720	PRL7	RIO DE JANEIRO, BRAZIL; "Radio Nacional"; 6 to 9:55 pm.	11.470	—	"NATIONAL CONGRESS RADIO" (India); 12:15 to 12:53 pm.	11.805	COGF	MATANZAS, CUBA; afternoon transmissions.
9.735	CSW	LISBON, PORTUGAL; 2 to 5:33 pm; 8 to 9:02 pm.	11.470	—	"AZAD MOSLEM RADIO"; 9:30 to 9:45 am.	11.81	2RO22	ROME, ITALY; off since September 8th.
9.750	—	ROME, ITALY; off since September 8th.	11.6	—	"RUMANIAN FREEDOM STATION"; 1:45 to 1:55 pm; 4:15 to 4:25 pm.	11.830	WCRC	NEW YORK CITY; Latin American beam, 5:30 pm to midnight; European beam, 6 am to 4:45 pm.
9.750	WKLJ	NEW YORK CITY; North African beam, 3:15 to 7 am; 4:30 to 11:45 pm.	11.623	COK	HAVANA, CUBA; noon to midnight.	11.840	CMCH-CMCX	HAVANA, CUBA; late afternoons.
9.780	—	ITALIAN UNDERCOVER STATION; variable times of evenings, afternoons.	11.633	—	"HUNGARIAN NATIONS RADIO"; 1:15 to 1:27 pm.	11.84	VLG4	MELBOURNE, AUSTRALIA; Asia beam (Chinese, English, Malay, Dutch), 6:15 am.
9.825	GRH	LONDON, ENGLAND; North American beam, 5:15 pm to 12:45 am.	11.680	GRG	LONDON, ENGLAND; North America beam, 1:15 pm to 6:30 pm.	11.847	WGEA	SCHENECTADY, NEW YORK; European beam, 6:15 am to 4:45 pm; Brazilian beam, 5 to 8:15 pm.
9.830	GRX	LONDON, ENGLAND.	11.675	OPL	LEOPOLDVILLE, BELGIAN CONGO; 1 to 6:15 pm.	11.855	DJP	BERLIN, GERMANY.
9.835	—	"HUNGARIAN NATIONS RADIO"; 3:15 to 3:27 pm.	11.697	HP5A	PANAMA CITY, PANAMA; news (English) 7:15 pm.	11.870	WBOS	BOSTON, MASSACHUSETTS; European beam, 5:45 to 7 am.
9.84	CR7BE	MOZAMBIQUE; news (English), 4:50 pm daily.	11.705	—	FRENCH INDO CHINA; "Radio Saigon," not heard recently.	11.870	WNGI	NEW YORK CITY; East South America beam, 7 pm to midnight.
9.845	—	"RADIO NAZIONALE FASCISTI"; 3:30 to 5:57 pm.	11.705	SBP	MOTALA, SWEDEN; not heard recently.	11.87	VLI2	SYDNEY, AUSTRALIA; British beam 2:55 am.
9.860	—	MOSCOW, U.S.S.R.; heard mornings.	11.705	CXA19	MONTEVIDEO, URUGUAY; not heard recently.	11.893	WRCA	NEW YORK CITY; European beam, 5 to 8:45 am; 3 to 4:45 pm.
9.86	EAQ	MADRID, SPAIN; not heard in several weeks.	11.705	CBFY	VERCHERES, CANADA; 7:30 am to 11:30 pm.	11.893	WKTM	NEW YORK CITY; European beam, 6 to 8 pm.
9.890	—	? FREEDOM STATION; 3:15 to 3:28 pm.	11.710	WLWO	CINCINNATI, OHIO; European beam, 6:30 to 9 am; 3:45 to 5:15 pm.			
9.897	WKRD	NEW YORK CITY; European beam, 5 to 6:45 am.	11.71	VLG3	MELBOURNE, AUSTRALIA; Tahiti beam, news in French, 1:55 am; British beam (English) 2:55 am; Pacific beam			
9.897	KROJ	LOS ANGELES, CALIFORNIA; N.E.I.-Oriental beam,						

(Continued on following page)

HERE IS YOUR SUCCESS CHANCE
BE A

RADIO-ELECTRONIC TECHNICIAN

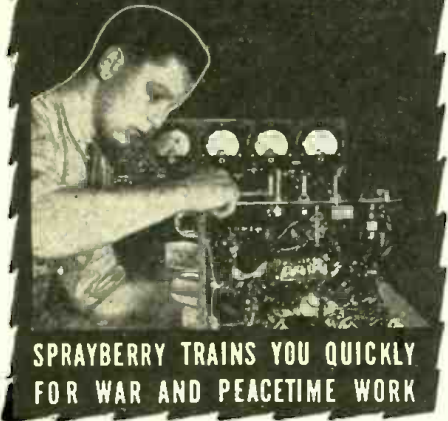

SPRAYBERRY TRAINS YOU QUICKLY
FOR WAR AND PEACETIME WORK

You Do Practice-Giving Experiments With
Real Equipment



The offer I make you here is the opportunity of a lifetime. It's your big chance to get ready for a wonderful future in the swiftly expanding field of Radio-Electronics INCLUDING Radio, Television, Frequency Modulation, and Industrial Electronics. No previous experience is needed. Be wise!

NOW is the time to start.

You Get a Dual-Purpose Radio Set

I supply you with Radio Parts which you use to gain pre-experience in Repair work. These same Parts are used for testing and for Signal Training, etc. The Sprayberry course starts right at the beginning of Radio. You can't get lost. It gets the various subjects across in such a clear simple way that you understand and remember.

Prepares You for a Business of Your Own
... or Good Radio Jobs

I make it easy for you to learn Radio Set Repair and Installation Work ... by practical, proved, time tested methods. I teach you how to install and repair Electronic Equipment. Soon you'll be qualified for a good paying job in one of the nation's Radio plants doing war work OR, if you enter the Army, Navy, or Marines, my training will help you win higher rating and better pay. Let me prove what Sprayberry training can do for you.

JUST OFF THE PRESS!

"HOW TO TEST AND REPAIR
RADIO SETS WITHOUT
METERS"

YOURS FREE THESE
TWO VALUABLE
BOOKS!

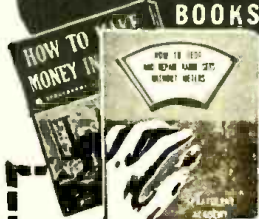

Developed in the Sprayberry Laboratory, this instructive volume tells about an amazingly simple, yet efficient method for Radio trouble shooting and repair without use of regular equipment made scarce due to war. Send for this FREE book now while the supply lasts and along with it, I will send you another big FREE book describing my Radio-Electronic training. Use coupon below.

MAIL COUPON

SPRAYBERRY ACADEMY OF RADIO
F. L. Sprayberry, President
Box 500 KL Pueblo, Colorado

Please rush my FREE copies of "HOW TO TEST AND REPAIR RADIO SETS WITHOUT METERS" AND "HOW TO MAKE MONEY IN RADIO."

Name Age

Address

City State

(Mail in plain envelope or paste on penny postcard)

THE LISTENING POST

(Continued from previous page)

Mc.	Call	Location and Schedule	Mc.	Call	Location and Schedule
11.900	XGOY	CHUNGKING, CHINA; Asia-Australia-New Zealand beam, 6 to 6:30 am; East Russia beam, 6:30 to 7 am; Japan beam, 7 to 7:30 am; European beam, 11:35 am to 12:30 pm.	15.195	TAQ	ANKARA, TURKEY.
11.900	XEW1	MEXICO CITY, MEXICO.	15.20	DJB	BERLIN, GERMANY; not heard recently.
11.900	CXA10	MONTEVIDEO, URUGUAY; evenings.	15.210	WBOS	BOSTON, MASSACHUSETTS; European beam, 7:15 to 9:30 am; 11 am to 5:15 pm; North European beam, 9:45 to 10:45 am; East South America beam, 5:30 to 8:15 pm.
11.9	VLG9	MELBOURNE, AUSTRALIA; Asia beam (English) 10:15 am.	15.220	—	"NATIONAL CONGRESS RADIO" (INDIA); 12:15 to 12:53 pm.
11.935	—	"SUDETEN GERMAN FREEDOM"; 7:35 to 7:55 am; 12:15 to 12:30 am; other times.	15.220	—	"VOICE OF FREE INDIA"; 10 am to 12:05 pm.
11.947	—	MOSCOW, U.S.S.R.; 7:30 to 11 pm.	15.220	—	"AZAD MOSLEM RADIO"; 9:30 to 9:45 am.
11.970	FZI	BRAZZAVILLE, FRENCH EQUATORIAL AFRICA; "Radio Brazzaville"; 3:45 to 4 pm; 4:45 to 5 pm; 7:45 to 8 pm.	15.225	JTL3	TOKYO, JAPAN; 6:15 to 8:15 pm; news in English at 6:20 pm.
12.060	FFZ	SHANGHAI, CHINA; heard at 8 am.	15.230	—	KOMSOMOLSK, U.S.S.R.; not heard recently.
12.11	—	ALGIERS, NORTH AFRICA; 1 to 5:30 pm.	15.230	VLG6	MELBOURNE, AUSTRALIA; Western North America, evenings; news at 1:10 am in English.
12.115	ZNR	ADEN, ARABIA; 1 to 1:30 pm.	15.240	TPC5	VICHY, FRANCE; 11:15 am to 1:30 pm.
12.130	DZE	BERLIN, GERMANY.	15.250	WLWK	CINCINNATI, OHIO; European beam 8:30 am to 5:15 pm; West South America beam, 5:30 to 8:15 pm.
12.19	—	MOSCOW, U.S.S.R.; not heard recently.	15.270	WC8X	NEW YORK CITY; European beam, 7 am to 4:45 pm.
12.235	TFJ	ICELAND; heard early mornings; irregular.	15.290	KWID	SAN FRANCISCO, CALIFORNIA; Oriental beam, 1 to 2:45 am; South American beam, 1 to 9 pm.
12.445	HCJB	QUITO, ECUADOR; "Voice of the Andes"; 5 to 11 pm except Monday; in English to 10 pm; other times in Spanish.	15.290	WKLJ	NEW YORK CITY; North African beam, 7:15 am to noon.
12.967	WKRD	NEW YORK CITY; European beam, 3:45 to 6:30 pm.	15.300	2RO6	ROME, ITALY; off since September 8th.
12.967	WKRX	NEW YORK CITY; North African beam 6 to 8 am.	15.320	JFY	TAIHOKU, JAPAN.
14.460	DZH	BERLIN, GERMANY; 10 to 10:45 am.	15.32	GSP	LONDON, ENGLAND; afternoons.
14.480	—	EL SALVADOR; not heard recently.	15.32	VLI3	SYDNEY, AUSTRALIA; Western North America beam, evenings; news at 1:10 am in English.
15.105	JLG4	TOKYO, JAPAN; 2 to 4 am.	15.330	WGEO	SCHENECTADY, NEW YORK; European beam, 7 to 9:45 am; 10 am to 3 pm; 3:15 to 5:15 pm.
15.110	GSF	LONDON, ENGLAND.	15.33	KGEI	SAN FRANCISCO, CALIFORNIA; off the air at present.
15.11	DJL	BERLIN, GERMANY.	15.345	FGA	DAKAR, SENEGAL (AFRICA); 2:45 pm to 7.
15.11	—	MOSCOW, U.S.S.R.; 5:47 to 7:15 pm; 9:15 to 9:40 pm; 11:15 to 11:40 pm.	15.350	WRUL	BOSTON, MASSACHUSETTS; European beam, 10 to 11:45 am; noon to 6 pm.
15.11	—	KOMSOMOLSK, SIBERIA, U.S.S.R.; 7:40 to 8:20 am; 5:15 to 5:40 pm; 6:48 to 7:25 pm; 9:15 to 9:40 pm; 11:15 to 11:40 pm.	15.355	KWU	SAN FRANCISCO, CALIFORNIA; Australian beam, 4:30 to 6:15 pm daily, Sundays, 4:45 to 6:15 pm; N.E.I.-Oriental beam, 7:45 to 9:30 pm; off on Wednesdays.
15.130	WRUS	BOSTON, MASSACHUSETTS; North African beam, noon to 7:15 pm.	15.370	ZYC8	RIO DE JANEIRO, BRAZIL; 10 am to noon.
15.150	WRCA	NEW YORK CITY; Brazilian beam, 5 to 7:45 pm.	15.410	RV99	MOSCOW, U.S.S.R.
15.150	WNBI	NEW YORK CITY; European beam, 6 am to 4:15 pm.	15.465	2RO24	ROME, ITALY; off since September 8th.
15.155	SBT	MOTALA, SWEDEN; not heard recently.	15.465	PRE9	FORTALEZA, BRAZIL; not heard recently.
15.16	—	BRAZIL; 6:30 pm.	15.750	—	MOSCOW, U.S.S.R.; not heard recently.
15.170	TGWA	GUATEMALA CITY, GUATEMALA; daytime.	15.80	LRF3	ARGENTINA; late afternoons.
15.175	—	EL SALVADOR; not heard recently.	16.025	AFHQ	ALGIERS; not heard recently.
15.190	KROJ	LOS ANGELES, CALIFORNIA; N.E.I.-Oriental beam, 2:30 to 8:45 pm.	17.090	KMI	SAN FRANCISCO, CALIFORNIA; 11 am to 2 pm.
15.190	WKRD	NEW YORK CITY; Central Africa beam, 7 to 9 am.			
15.190	WKRX	NEW YORK CITY; North European beam, 10 am to 12:45 pm; Central Africa beam, 1 to 5 pm.			
15.19	OIX4	LAHTI, FINLAND; not heard recently.			

(Continued on page 192)

METER ERRORS—THEIR CAUSES

(Continued from page 143)

resents an error of $2/50 \times 100 = 4\%$ of the quantity being measured; for a 10-volt reading (made at 1/10 scale) it represents a $2/10 \times 100 = 20\%$ error; for a 4-volt reading (made at the extreme low end of the scale) it represents a $2/4 \times 100 = 50\%$ error, and so on.

Fig. 1 summarizes in graphic form the interesting results of a check made on the 10-volt scale of a D.C. voltmeter of a type used in radio service work, against a laboratory standard. This is not presented as a typical example, but serves for purposes of illustration. Although this instrument had seen considerable service, and probably some abuse, it was still well within the manufacturer's "2% of full scale" accuracy rating except at the extreme low end. This is shown by the broken-line curve. As a matter of fact, an accuracy of better than 1/2% (of full scale) is maintained over approximately 50% of the range of the instrument.

WHAT RANGE SHOULD BE USED?

The actual quantitative error expressed in per cent of the measured quantity for different parts of the scale is shown by the solid-line curve. Here it will be seen that all voltages between about 3.6 and 10 will be measured with an error of 2% or less, but measurements of voltages below 3.6 will show rapidly increasing errors. For example, a voltage of 2 volts would be measured with 6% error; one of 1 volt would be measured with 17% error, etc. For service work this range of the instrument is adequately accurate for all measurements above about 2 volts, or throughout the upper four-fifths of the scale. It would be unwise to employ it for measurements below this value.

An extensive study of the inaccuracy inherent in a wide variety of modern test equipment indicates that as a general rule it is best never to take measurements that put the reading in the first fifth of the scale, because it is in this portion that the maximum actual quantitative error in per cent of the measured quantity is invariably encountered. Since the accuracy over the upper four-fifths of the scale is much higher, if a voltage (or current) under measurement falls in the lower fifth of an instrument scale it is far better to switch to the next lower range (if one is available) where the desired value will be indicated further up on the scale. Hence the general rule:

In permanent-magnet moving-coil type instruments the upper four-fifths of the instrument scale for any particular range is a more accurate section on which to take readings than is the first fifth to third portion of the scale on the next higher range.

Observance of this rule is one of the practical methods by which the user of an instrument having the usual inherent inaccuracy characteristic of Fig. 1 can insure obtaining the most accurate measurements his instrument is capable of.

METER READING ERRORS

Observational errors (about which we shall have more to say later in this series) have less effect if the pointer position is at the upper region of the scale. In reading the pointer position at a very low part of a uniformly-divided scale, a given observational error, of perhaps 0.005-inch, causes a greater percentage of error in the actual quantity read than the same 0.005-inch error would cause were the reading taken

at the middle or upper part of the scale where the numerical values are larger. That is, observational errors have a greater percentage effect on the accuracy of low-on-the-scale readings than they do on high-on-the-scale readings.

For these and other reasons, when cost will permit, test instrument manufacturers design almost all their electrical indicating instruments so that a sufficient number of overlapping ranges are available. The ratio of succeeding ranges in these multi-stage test instruments is usually 2, 5, or 10 (that is, full-scale value of any range is either 2, 5, or 10 times that of the immediately

lower range). Consequently, no measurements ever need result in a reading on the undesirable first one-fifth portion of a scale. By using the next lower range, the reading will be thrown to a higher point on the scale, where greater inherent and observational accuracy is obtained. The percentage of error due to characteristics of the meter, and to observational inaccuracy, are both reduced.

Far-thinking radio and electronic test instrument manufacturers carefully plan the upper and lower limits of their ranges so that a fairly large proportion of the

(Continued on following page)

Get into RADIO now!

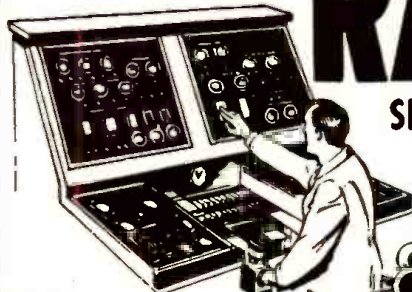

SHOP METHOD HOME TRAINING
fully qualifies you for bigger pay jobs

More than 50,000,000 radios in use. They need servicing. Over 800 Broadcasting Studios employ trained radio technicians. The movie industry and thousands of theatres employ Sound experts. Factories are adopting audible address system. The Air Lines and Government need Trained Men. Here is your opportunity to get into a permanent, profitable field of enjoyable work.

BIG OPPORTUNITY FOR NATIONAL GRADUATES

Shortages in trained, skilled men run into the hundreds of thousands. One of the biggest fields is RADIO, with its many fascinating branches. Wartime demands for Radio men are tremendous and will continue UNABATED after the war. That's important to you. You want training in a field that will continue to advance. National Schools offers you a time-tested method of Home Training which has helped thousands of men to more pay, and unlimited opportunity in the growing RADIO industry. You can actually start earning in Spare Time, even while you are training for a good permanent job as a RADIO technician. You need training. National can definitely help you. Simply send the Coupon and we will mail you a FREE Specimen Lesson and Big Opportunity Book so you can judge for yourself just how you can be helped to bigger pay and a Life Career of Success.



COMMAND ANY OF THESE JOBS
Radio Expert
Radio Broadcasting
Sound
Talking Pictures
Studio Technician
Television Technician

Your opportunity to learn
RADIONICS
which includes
RADIO ELECTRONICS & TELEVISION

YOU GET HOME TRAINING FROM A REAL, ESTABLISHED TECHNICAL TRADE SCHOOL

REGARDLESS OF YOUR AGE YOU CAN ENROLL

"I will train you in your spare time to qualify as a Radio Expert."
J. A. Rosenkranz
President

For 39 years National Schools has trained ambitious men for Top Pay trades. Squared behind you are the modern, completely-equipped Training Shops of National where we pre-test and prove every instruction sent to you. Every phase of your training is personally supervised by an established Faculty of practical experienced instructors and engineers. They have developed progressive methods of training you in your home comparable to actual shop practice. Unique training facilities give you Home Training based on Resident School Shop principles—methods not available from any other source, to our knowledge. You'll be amazed when you receive our Complimentary Lesson and full details. Send the Coupon at once.

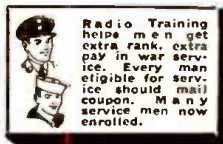

Duplicate the Success of These Graduates



O. K. IVEY H. SCHROEDER
"National Schools has done wonderful work for the man who wants to get ahead in life. Your trained man can get a job at a much higher salary."
O. K. Ivey, D. C.
Washington, D. C.

"Your schooling helped me obtain a swell job. Now, in the Navy, I am following the profession I learned at National. It will help my chances for rapid advancement."
H. Schroeder, U. S. Navy.

Thousands of Graduates Attribute Their Success to National Training



FREE LESSON & OPPORTUNITY BOOK



NATIONAL SCHOOLS

Los Angeles California

ESTABLISHED 1905

MAIL OPPORTUNITY COUPON FOR QUICK ACTION

National Schools, Dept. RC-12 (Mail in envelope or paste on penny postcard)
4000 So. Figueroa, Los Angeles, Calif.
Mail me FREE, without obligation, one Lesson and Opportunity Book, with full details about how I CAN become a RADIO Technician.

NAME _____ AGE _____
ADDRESS _____
CITY _____ STATE _____

REQUEST FULL DETAILS

OHMITE "DIVIDOHM"

Adjustable
Resistors

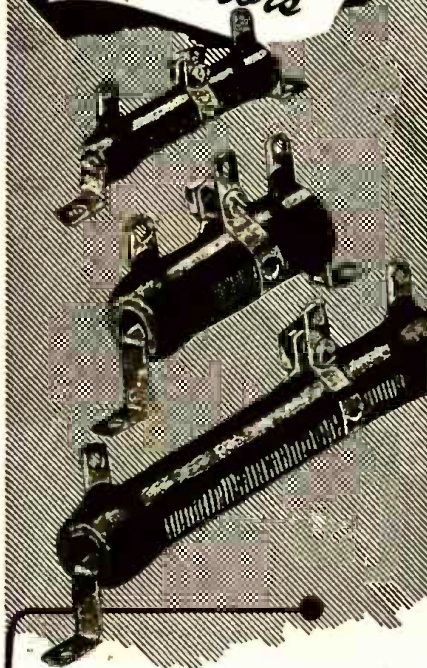

Ohmite "Dividohms" make ideal voltage dividers by the use of one or more adjustable lugs. Also handy for obtaining odd resistance values, for adjusting circuits, and for use on equipment which must be set to meet various line voltages.

The "Dividohms" are wire wound on ceramic cores, and vitreous enameled. A narrow strip of the wire is exposed for contact with the adjustable lug. Every turn of wire is securely held against shifting. Stock units made in 10, 25, 50, 75, 100, 160, 200 watt sizes—wide range of resistance values.

Write for Free Catalog 18

Ohmite Manufacturing Co.
4896 Flournoy St., Chicago 44, Illinois



Handy Ohm's Law Calculator

Helps you figure ohms, watts, volts, amperes—quickly, easily. Solves any Ohm's Law problem with one setting of the slide. Send 10c in coin to cover handling, mailing. (Available in quantities.)

Be Right with OHMITE
RHEOSTATS · RESISTORS · TAP SWITCHES

METER ERRORS—THEIR CAUSES

(Continued from previous page)

readings that are taken during the everyday troubleshooting and testing of the circuits and parts of radio receivers and electronic equipment fall at or near three-fourths to four-fifths full-scale deflection (usually the most accurate part of the scale). The usual 2.5-volt range, for example, is used mostly for checking the 2.5-volt tube filament voltage. The 10-volt range can check 6.3-volt and 5-volt filament voltages. Line potentials of from 100 to 130 volts fall nicely on a 150-volt scale—or even on a 250-volt scale. Plate supply potentials, being from 200 to 250 volts, can be easily cared for on a 250-volt range, higher voltages on the 500-volt or 1000-volt range, etc. The various ranges of a typical modern multi-range indicating instrument are illustrated in Fig. 2. Notice the scales for the various ranges.

For these reasons, the serviceman should form a habit of using the available ranges on his test instruments most advantageously. Because of these inherent and observational error characteristics, a safe general rule for readings made on permanent-magnet, invariable-coil instruments, is:

If possible, choose a range which places the reading in the upper four-fifths region of the scale.

OHMMETER ACCURACY; RANGE SELECTION

Ohmmeter scales do not have uniformly-spaced divisions. At the high end of the scale 1/16 inch of scale length may represent only 1 ohm, while at the lower end 1/16 inch may represent as much as 1000 ohms. Furthermore (except in the electronic type ohmmeters), the zero-deflection end of the scale usually represents infinity ohms, and the full-deflection end is usually the zero ohms end. (See Fig. 2.) Because of the non-uniform scale, and because the zero-ohm position is usually at the full-scale end, we cannot express the inherent accuracy of an ohmmeter on the basis of a percentage of the full-scale reading as is done for uniform-scale voltmeters, ammeters, etc. However, we do use basically the same rating. Instead of using

ohms as a measure of the accuracy we use per cent of the degrees of full-scale angular deflection of the pointer, or per cent of the total scale length in inches (A.I.E.E. definition). That is, if a 2% inherent accuracy is specified, this would mean that the position of the pointer for any ohms measurement made on that range is accurate to within plus or minus 2% of the full-scale length in inches (or full-scale angular deflection in degrees).

To interpret the possible error in terms of ohms we would have to know how many ohms this "±2% of full-scale length" variation is equivalent to at the particular point on the scale where the reading is being taken. This could be determined by inspecting the scale at this point.

Most ohmmeters employ a D.C. permanent-magnet movable-coil type instrument whose inherent accuracy is within 2%. Therefore, for such an instrument the error for any reading will not exceed ±2 per cent of the full-scale length. If the full-scale length is 4 inches, then a 2% error is $2/100 \times 4 = 0.08$, or 1/12 of an inch. Therefore, anywhere along the scale of the instrument the error may be as great as plus or minus whatever number of ohms 1/12 of an inch scale length at that point is equivalent to. At half scale, on an ohmmeter having a mid-scale reading of 50 ohms, an error of 1/12 inch on a particular ohmmeter may be equivalent to 4 ohms. On a percentage basis this would be an 8 per cent error. Because of the greater crowding of the divisions on the scale toward the left-hand end, for one-fourth scale deflection (reading 140 ohms) the same error of 1/12 inch might be equivalent to about 16 ohms, or 11% of 140.

Since the error gets rather high at low values of deflection, with normal ohmmeter scales, it is wise, whenever possible, to choose a range which causes the pointer deflection to fall somewhere between one-half and full-deflection. At any rate, avoid (whenever possible) taking readings over the first fifth of the scale.

(A further installment of this series will appear in an early issue.)

NEW WARTIME TUBES

(Continued from page 147)

consists of two pentodes with a common cathode. The units may be connected either in parallel or push-pull.

A full-wave high-vacuum rectifier, the 5R4-GY, supplies heavy currents at somewhat higher voltages than the former heavy-duty receiver type rectifiers. Its average output of 250 Ma. is at a rated peak inverse voltage of 2400.

Characteristics of these tubes are given in the lists below:

RCA-9006 U-H-F DIODE Midget Type	
Heater Voltage (A.C. or D.C.)	6.3 Volts
Heater Current	0.15 Ampere
Maximum Ratings Are Design-Center Values	
Peak Inverse Plate Voltage	750 max. Volts
Peak Plate Current	15 max. Milliamperes
D-C Output Current	5 max. Milliamperes
D-C Heater-Cathode Potential	100 max. Volts
Typical Operation as Rectifier:	
A-C Plate Supply Voltage (RMS)	270 Volts
Min. Total Effective Plate-	

Supply Impedance	100 Ohms
D-C Output Current	5 Milliamperes

RCA-6AK6 POWER AMPLIFIER PENTODE

Miniature Type (Tentative Data)	
Heater Voltage (A.C. or D.C.)	6.3 Volts
Heater Current	0.15 Ampere
Maximum Ratings Are Design-Center Values	
Plate Voltage	300 max. Volts
Screen Voltage (Grid No. 2)	250 max. Volts
Plate Dissipation	2.75 max. Watts
Screen Dissipation	0.75 max. Watts
D-C Heater-Cathode Potential	100 max. Volts
Typical Operation and Characteristics—Class A ₁ Amplifier:	
Plate Voltage	180 Volts
Suppressor (Grid No. 3)	Connected to cathode at socket
Screen Voltage	180 Volts
Grid Voltage (Grid No. 1)*	-9 Volts
Peak A-F Grid Voltage	9 Volts
Zero-Signal Plate Current	15 Milliamperes
Zero-Signal Screen Current	2.5 Milliamperes
Plate Resistance	0.2 Megohm

Transconductance	2300	Micromhos
Load Resistance	10000	Ohms
Total Harmonic Distortion	10	%
Max.—Signal Power Output	1.1	Watts
* The D-C resistance in the grid circuit under maximum rated conditions should not exceed 0.5 megohm for cathode-bias operation and 0.1 megohm for fixed-bias operation.		
RCA—12L8-GT		
TWIN-PENTODE POWER AMPLIFIER		
Heater Voltage (A.C. or D.C.)	12.6	Volts
Heater Current	0.15	Ampere
Maximum Ratings Are Design-Center Values Amplifier—Each Unit		
Plate Voltage	180 max.	Volts
Screen Voltage	180 max.	Volts
Plate Dissipation	2.5 max.	Watts
Screen Dissipation	1.0 max.	Watt
D-C Heater-Cathode Potential	100 max.	Volts
Typical Operation and Characteristics—Class A ₁ Amplifier:		
Plate Voltage	180	Volts
Screen Voltage (Grid No. 2)	180	Volts
Grid Voltage (Grid No. 1)	-9	Volts
Peak A-F Grid Voltage	9	Volts
Zero-Signal Plate Current	13	Milliamperes
Max.—Signal Plate Current	13.5	Milliamperes
Zero-Signal Screen Current	2.8	Milliamperes
Max.—Signal Screen Current	4.6	Milliamperes
Plate Resistance	0.16	Megohm
Transconductance	2150	Micromhos
Load Resistance	10000	Ohms
Total Harmonic Distortion	10	%
Power Output	1	Watt

RCA—5R4-GY		
FULL-WAVE HIGH-VACUUM RECTIFIER		
(Tentative Data)		
Maximum Ratings Are Design-Center Values Full-Wave Rectifier		
Peak Inverse Voltage (No-Load Conditions)	2800 max.	Volts
Peak Plate Current per Plate	650 max.	Milliamperes
With Condenser-Input Filter:		
A-C Plate Voltage per Plate (RMS)		
Full Load	700	900
No Load	750	1000
Total Effective Plate-Supply Impedance per Plate†	125	575
Current	250 max.	150 max.
With Choke-Input Filter:		
A-C Plate Voltage per Plate (RMS)		
Full Load	750	950
No Load	850	1000
Input-Choke Inductance	5 min.	10 min.
D-C Output Current	250 max.	175 max.
See curve for conditions necessitating delay in application of plate voltage until filament has reached operating temperature.		
Horizontal operation is permissible if pins 1 and 4 are in a vertical plane.		
† When a filter-input condenser larger than 4μf is used. It may be necessary to use more plate-supply impedance than the value shown to limit the peak plate current to the rated value.		

RCA—6AG5				
R-F AMPLIFIER PENTODE				
Miniature Type				
(Tentative Data)				
Maximum Ratings Are Design-Center Values Amplifier				
Plate Voltage	300 max.	Volts		
Screen Voltage	150 max.	Volts		
Plate Dissipation	2 max.	Watts		
Screen Dissipation	0.5 max.	Watt		
Typical Operation and Characteristics—Class A ₁ Amplifier:				
Plate Voltage	100	125	250	Volts
Screen Voltage (Grid No. 2)	100	125	150	Volts
Cathode-Bias Resistor	100	100	200	Ohms
Plate Resistance (Approx.)	0.3	0.5	0.8	Megohm
Transconductance	4750	5100	5000	Micromhos
Grid Bias for Plate Current = 10 μamp.	-5	-6	-8	Volts
Plate Current	5.5	7.2	7	Milliamperes
Screen Current	1.6	2.1	2	Milliamperes

The center hole in sockets designed for this base provides for the possibility that this tube type may be manufactured with the exhaust-tube tip at the base end. For this reason, it is recommended that in equipment employing this tube type, no material be permitted to obstruct the socket hole.

SYLVANIA—TYPE 28D7		
DOUBLE BEAM POWER AMPLIFIER		
Ratings		
Heater Voltage	28.0	Volts
Heater Current	0.400	Ampere
Maximum Plate Voltage (Per Section)	100	Volts
Maximum Screen Voltage (Per Section)	67.5	Volts
Maximum Plate Dissipation (Per Section)	3.0	Watts
Maximum Screen Dissipation (Per Section)	0.5	Watt
Operating Conditions and Characteristics Resistance Coupled Amplifier Class A ₂ (Per Section except heater)		
	Self Bias	Fixed Bias
Heater Voltage	28.0	28.0
Heater Current	0.400	0.400
Plate Voltage	28.0	28.0
Screen Voltage	28.0	28.0
Grid Voltage	—	-3.5
Cathode Bias Resistor	390	—
Zero Signal Plate Current	9.0	12.5
Zero Signal Screen Current	0.7	1.0
Maximum Signal Plate Current	6.5	8.1

Current	1.6	1.9	Ma.
Plate Resistance	—	4200	Ohms
Transconductance	—	8400	μmhos
Peak A-F Signal Voltage	4.9	4.9	Volts
Control Grid Resistor per Section	0.5	0.2	Megohm
Load Resistance	4000	4000	Ohms
Power Output	80	100	Mw.
Total Harmonic Distortion	10	100	Percent
Push-Pull Operation Transformer Coupled Class A ₂ (Values are for both sections)			
Heater Volts	28.0	Volts	
Plate Voltage	28.0	Volts	
Screen Voltage	28.0	Volts	
Grid Voltage	0	Volts	
Cathode Bias Resistor	0	Ohms	
Zero Signal Plate Current	64.0	Ma.	
Zero Signal Screen Current	4.0	Ma.	
Maximum Signal Plate Current	58.0	Ma.	
Maximum Signal Screen Current	17.0	Ma.	
Peak A-F Signal Voltage (Grid to Grid)	12.6	Volts	
Load Resistance (Plate to Plate)	1500	Ohms	
Total Harmonic Distortion	11.0	Percent	
Power Output	600	Mw.	
Note: The above characteristics may be realized provided the d-c plate circuit resistance does not exceed 50 ohms per section.			



Your Meissner distributor will advise you on the Meissner replacement parts now available... while keeping our facilities devoted to the manufacture of vital electronic parts for war needs we have been doing our utmost to keep a replacement parts stock in the hands of Meissner distributors... a service which we, here at Meissner, are doing to help keep 'em playing.

See your Meissner distributor today... he will tell you just what parts are available now.



"PRECISION-BUILT ELECTRONIC PRODUCTS"

TRIPLETT

Practi-Quality

PRECISION—DURABILITY—FAIR PRICES

TRIPLETT MODEL 645 PORTABLE

Hinged cover protection. Opens flush. Smooth case open or closed. Molded shield protects movement, excludes dust, permits plug-in thermocouple or rectifier replacements without exposing sensitive mechanism. Pre-calibration of thermocouples or rectifiers made possible by interchangeable plug-in units. No re-calibration required. In burn-out of thermocouple or rectifier new replacement can be affected "on the job."

For more data on 645 and same case style instruments write for 645 data sheet.

BUY WAR BONDS and STAMPS

THE TRIPLETT ELECTRICAL INSTRUMENT CO.
BLUFFTON, OHIO

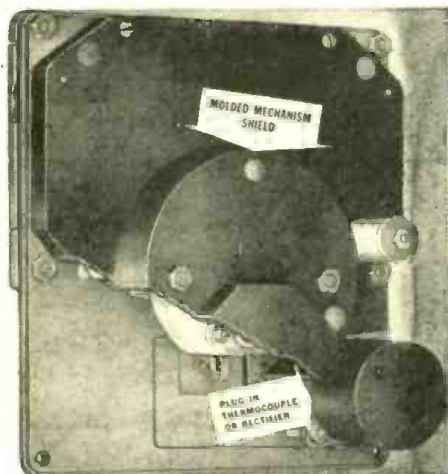

Help THE WAR EFFORT!!

Put your idle or new electrical test equipment to use on our production line

This equipment urgently needed by our engineering department. Communicate at once!!

Manufacturer	Quantity	Ballantine Equipment	Range	Type
Manufacturer	1	Electronic Voltmeter		300 A
Manufacturer	1	Boonton Radio Corp. Q. Meter		160 A
Manufacturer	1	Cornell Dubilier Capacitor Decade		CD A-5
		"		CD B-3
		"		CD C-3
		"		BF 50
Manufacturer	1	Analyzer		
Manufacturer	1	A. B. Dumont Laboratories Cathode Ray Oscillograph	2-100 Kc. 208-Cat # 1146	
	1	Cathode Ray Oscillograph	20-Cps.-2Mc. 224-Cat # 1191	
Manufacturer	1	General Radio Wave Meter (Plus Ind. coils)	16 Kc.-50Mc.	724 A
		Wave Meter	55-400Mc	758 A
		Standard Signal Generator		605 B
		Stroboscope		631 B
Manufacturer	1	Hewlett-Packard Company Audio Signal Generator	205 A G	
		Secondary Frequency, Standard, with temperature control crystal		100 B
Manufacturer	2	R. C. A. Mfg. Co. Volt Ohmyst Junior		165
Manufacturer	1	Leeds & Northrup Potentiometer # 7552		K-2
		Emley Hand Cell		7308
		Lamp and Scale		2100
		Galvanometer		2500
		Bracket		2147

State full details on type of equipment available. Write to M. Ryan, Equity Advertising Agency, 113 West 42nd St., N. Y. C.

LIGHT-PHONE USED BY NAZIS

(Continued from page 152)

frequencies, and gaseous discharge lamps do not seem to be the answer.

The best method appears to be to modulate the beam after the source, and for this, several methods, allied to talking picture technique, have been tried. But before the war speech-on-light signaling was still in the experimental stages, except for this German set.

In all such systems, the modulated beam must be sharply focused onto the distant station, at which a photo cell is used to detect the changes in light intensity and to convert them into voice currents.

Considering the transmission system first, we start with the lamp. This has a coiled filament, is supplied with 4.8 volts, and consumes 4 watts. The lamp is held in an accurately made, detachable holder, the filament is pre-focused and the lamp base has a guide pin which engages with a groove in the holder. The lamp holder fixes into the lamp house, containing a mirror which focuses the light onto the modulator unit.

After the modulator, the light beam passes through a filter, which may be white, red, infra-red, or diffused, depending on the setting of the filter selector knob. The light beam, being now modulated and filtered, passes through an 80 mm. lens, which focuses it to a virtually parallel beam.

THE MODULATOR

The action of the modulator is best understood by reference to Fig. 2. The light beam is reversed in direction by two internal reflections of the prism. The other angles of the prism are not quite 45 degrees, so that at the point of first reflection the mean angle of incidence is approximately the critical angle for glass and air media. Under these conditions, partial reflection and partial refraction takes place. The area at which this first reflection takes place is a small rectangle measuring 3 by 1½ mm., the surrounding glass being blackened. The armature consists of a flat metal strip, pivoted at its center. Its ends are located closely between the pole pieces of the armature coils, which are so phased that one pushes and the other pulls. A small right angle prism is carried on the armature, near its

center, and it is so positioned that one of its sides rests in contact with the small rectangle of the main prism. As the armature moves in accordance with the voice currents, so the pressure of the small, moving prism against the large prism, changes in accordance with the voice currents.

It will be appreciated that since the small prism is mounted close to the axis of rotation of the armature, its travel is small, but its pressure is great. When considering the action of the device, it is necessary to bear in mind that it is the pressure of the small prism on the large one that alters—not so much the air gap between the two. Let us consider the state of affairs that would exist if these two glass surfaces were truly optically flat and in perfect contact. Obviously there would be no change of medium at this point and no internal reflection would take place. Hence no light would pass through the main prism. But as soon as the contact between the prisms becomes imperfect, a change of light media will occur—and internal reflection will result. In practice, the contact is never perfect. In fact, for all pressures of the prism, most of the light is reflected. But the varying pressure brings about a varying degree of contact which, in its turn, varies the amount of light reflected through the main prism. This, coupled with the fact that the angle of incidence is nearly the critical angle, makes the modulator a relatively efficient device.

A device is incorporated to control the quiescent, no-signal pressure of contact. The operator is supposed to adjust this to give maximum sensitivity and minimum distortion. The action of this device is interesting, in that it controls, to some extent, the direction of modulation. It is paradoxical to say that overall upward modulation takes place, if one is considering the amount of light that enters the prism; but with respect to the quiescent light level leaving the prisms (i.e., taking into account the amount lost at the first reflection for zero signal) it appears that upward and downward modulation does occur.

No attempt has been made to measure the depth of modulation, but if the instrument is

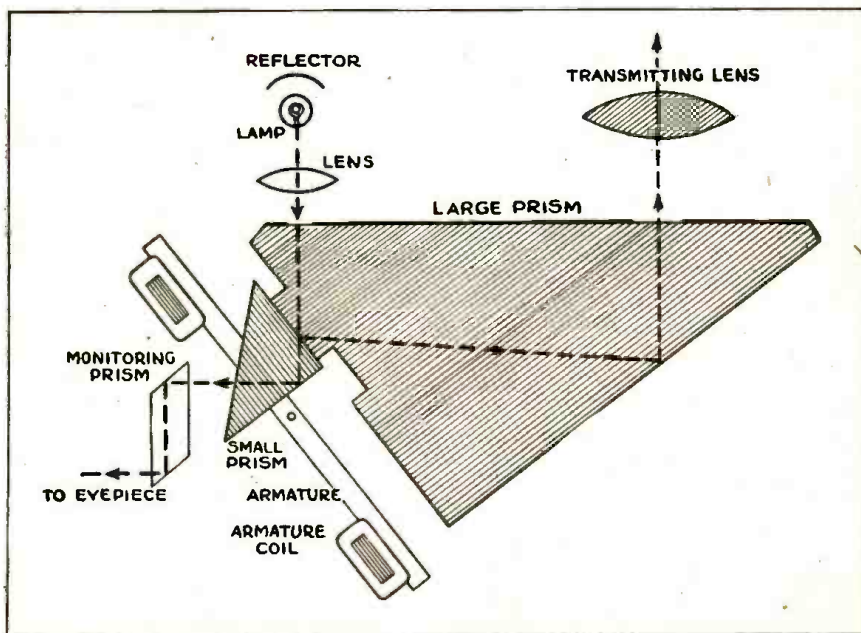

Fig. 2.—Changing pressure between the prisms varies amount of light reaching the lens.

In the first 10 days of operations in Italy, Signalmen laid 400 miles of fixed wire in addition to 300 miles of assault wire.

operated on white light, and an observer stands in the beam, a very marked flicker is noted when the operator speaks.

THE RECEIVING APPARATUS

The modulated filtered light (white, red, or infra-red), is picked up on the 80 mm. lens of the distant receiver, and focused on the photo cell, located at the back of the head. The photo cell changes the variations in light intensity into changes of electric potential, which are amplified by the one-stage photo-cell amplifier, located within the head. The A.F. output is fed by a cable to the main receiving amplifier, located in a box on the ground beside the tripod.

Separate amplifiers are used to send and receive, but both are mounted as one unit in a box containing the associated batteries, cables, spare tubes, lamps and photo cells. The photo-cell amplifier is conventional; the cell receives a positive voltage by means of a high resistance potentiometer from the high-voltage line. The anode circuit has a resistance-capacity network that attenuates at about 4,000 cycles, the purpose being presumably to minimize photo-cell hiss.

This amplifier uses two tubes, resistance-capacity coupled. The last tube is triode connected to secure a low impedance for the phones. The output is also taken to the telephone bridge input circuit; the operation of this will be discussed later.

The sending amplifier normally uses but one tube, triode connected. This is fed by the microphone, and the plate is parallel fed by an A.F. choke, the plate load being the armature coils of the modulator.

The send-receive switch normally switches on the appropriate amplifier, thus duplex operating is not possible. But for the purpose of working into a telephone line, the switch is turned to "Telephone," and this places the bridge circuit in the sender amplifier input—and in the receiver amplifier output. The bridge is balanced, to prevent acoustic feedback over the entire system. Naturally, the bridge input circuit offers some attenuation to the microphone current—so in this condition the switch puts another tube in the sender amplifier circuit to compensate for the attenuation of the bridge.

The audio frequency response of the amplifiers is shown in Fig. 3 and it will be noticed that both amplifiers have a falling response commencing just below mean voice frequency. The attenuation at 300 cycles per second and below is very high—and this feature is very useful in that it minimizes low frequency flutter due to hot air currents rising from the ground in the optical path.

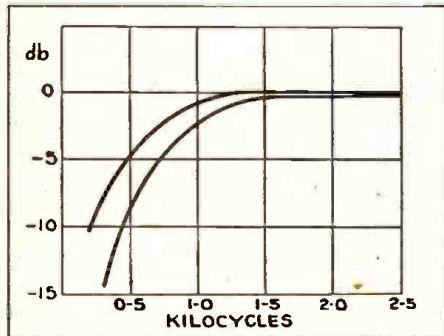

Fig. 3.—Audio Frequency response curve.

The cell is small in size, resembling a button about one inch in diameter. It is of the photo-conductive type, and changes its resistance in accordance to variations of light intensity. The cell is very sensitive

HARRISON HAS IT!

**FOR URGENT
WAR WORK—**

HALLICRAFTERS

**RECEIVERS AND
TRANSMITTERS**

**TUBES
CONDENSERS
RESISTORS
TRANSFORMERS**

**AND THOUSANDS OF OTHER
CRITICAL ELECTRONIC PARTS!**

PURCHASING AGENTS—

Call upon us for your high priority requirements of equipment and components for your production and development work.

We usually have it in stock!

**FOR THE
HOME FRONT—**

CODE PRACTICE SET

Buzzer and key, heavily nickel plated, of single unit construction, mounted on wood base. Adjustable high frequency pitch. Complete with silk covered card. In attractive box with code chart on cover. Works on one or two flashlight or dry cells.

Postpaid—\$2.45

6L6G First grade, **\$1.37 ea.**
meter tested. **3 for \$3.75**
TUBES fully guaranteed postpaid

DYKANOL CAPACITORS

Cornell-Dubiller oil filled, hermetically sealed metal cased condensers. 4 mfd. capacity. Rated at 220 Volts AC working, will stand over 600 Volts D.C. Ideal for amplifiers, receivers, power packs, etc. (Filtering action equivalent to 12 mfd. electrolytic but with better safety factor, longer life). \$2.25 (3 or more shipped postpaid).

P. M. DYNAMIC SPEAKERS

5 inch, with output transformer to match single plate of 8000 ohms **\$1.95**
Magnavox, 10 inch. 16 ounce magnet! 6 ohm voice coil **\$5.25**
(Not Postpaid)

Immediate delivery of the above items, without priority, while quantities last. **SEND REMITTANCE WITH ORDER. TODAY!** (Money back if not satisfied.)

HARRISON

RADIO CORPORATION

11 WEST BROADWAY

Phone WOrth 2-6276

NEW YORK CITY 7

to red and infra-red light, and a built-in red filter is incorporated. The output of the cell is in the order of one Ma. per lumen. The polarizing voltage is taken from the high-voltage line via a high resistance potentiometer and about 30 volts is applied to the cell. This relatively low voltage is desirable in order to keep the noise down, since such cells tend to be very noisy. The output of the cell is applied to the amplifier through a 100 mmf. condenser, which, together with the 10 megohm grid resistor, affords great attenuation at low frequencies.

The photo cell low-frequency response is good, but the curve falls off at the high-frequency end. In this respect, the cell is inferior to a caesium cell, which has a better R.F. response. However, its sensitivity to red and infra-red light is better than that of a caesium cell.

The effects of overloading, or over-modulating are to make the small moving prism lose all contact with the large one (on alternate half cycles); this makes the area of first reflection one of glass to air boundary. On the other half cycle, over-loading causes the prism pressure to be so great that the contact becomes too near perfect, and not enough light is reflected within the prism.

The Speech-on-Light apparatus provides another system of communication, but its use is strictly limited. First, the range is so small; secondly, it must be used over optical paths; and third, it cannot be operated on the move. The salient advantages are security as compared to short range radio, lack of wires as compared to telephones and provision for speech as compared to ordinary lamp signalling. It will be interesting to observe whether the Allies bring out a corresponding model.

(From an article by D. Gifford Hull, Capt., in the October, 1943, issue of *Electronic Engineering*, London.)

NAZI RADIO-CONTROLLED BOMB

In our November issue we reported the new German radio-controlled glider bomb. Here are some additional facts about it taken from the English magazine *Aeronautics*, November issue:

The Prime Minister's reference to this weapon having some system of wireless control embodied in its design recalls the fact that this country has not been behind in developing this invention. The practicability of the wireless-controlled pilotless aircraft was demonstrated years ago by the employment of the D.H. Queen Bee target-plane and the Airspeed Queen Wasp which appeared in 1936. The radio-controlled aircraft was first evolved in 1917, the preliminary work being done at the Royal Aircraft Establishment—known nowadays as the Royal Aircraft Factory—at Farnborough, Hants. Mr. H. P. Folland was mainly responsible for its design, and Professor A. M. Low (then a major in the Royal Flying Corps and now a captain in the Army) was one of those who worked on the wireless installation embodied in the design and general scheme. This first example of the wireless-controlled aeroplane was a small wire-braced monoplane fitted with an A.B.C. horizontally-opposed, two-cylinder, air-cooled engine, the 40 horsepower "Gnat." It flew with some success but finally crashed while being demonstrated before a number of high-ranking officers from the Air Board. In view of the Prime Minister's disclosure about the German rocket-bomb, and remembering the type used by our Russian ally, as well as the British efforts and achievements with radio-controlled aircraft in the past, some marked changes in bombing methods seem likely to arise before the end of the war.

THE OSCILLATOR—HOW IT OPERATES

(Continued from page 145)



Throat Microphones

For Aircraft Inter-Communication systems and radio telephone applications. These microphones open an entirely new field for industrial communications, allowing the wearer to make use of both hands without hampering his other movements. Ideal for use in noisy surroundings where communications must be made by use of headphones.

Model T-30 with CD-318 extension cord and switch, for U. S. Army Radio circuits, now available to priority users through local radio jobbers.

Write for Catalogue No. 961

UNIVERSAL MICROPHONE CO., LTD.

INGLEWOOD, CALIFORNIA

CANADIAN DIV: 560 KING ST. WEST, TORONTO 2
FOREIGN DIV: 301 CLAY, SAN FRANCISCO 11, CAL.



tire cycle begins anew. Since the grid voltage is quite unlikely to become sufficiently negative to drive the plate current to zero, this type of oscillator draws current constantly and quite a bit of heat will have to be dissipated by the plate. This may cause overheating and short tube life.

THE GRID-LEAK AND CONDENSER

To overcome the difficulties associated with an oscillator operating with constant plate current, (Class "A") we insert a condenser between the grid and coil. This condenser is called the grid condenser. The grid condenser is paralleled by a resistor having a high resistance. This is called the "grid leak." See Fig. 5.

The action of this simple combination is as follows:

When the tube is in a state of oscillation, the grid is swung from negative to positive at a very high frequency. During the positive portion of the cycle it becomes sufficiently positive to attract a portion of the electrons from the filament. Due to the blocking action of the grid blocking condenser, these electrons have no way of leaving the grid. Soon a sufficient number of electrons is accumulated to make it become negative. This will cause a decrease in plate current, and if the electrons continue to accumulate upon the grid, the plate current will reach a point where it is insufficient to sustain oscillations.

If a resistor is placed in parallel with the grid condenser or between the grid and filament, it will enable the electrons to find a path to ground and the tube will then oscillate steadily. In some types of circuits, this grid leak resistor, may be used to place a bias voltage on the grid, due to the fact that the flow of electrons is in such a direction as to make the grid negative with respect to the cathode. The improved circuit utilizing a grid leak and condenser is shown in Fig. 5a.

A FEW STANDARD CIRCUITS

This oscillatory circuit is known as an Armstrong Series-fed Oscillator. In this circuit, the coils, L_1 and L_2 are so placed that their longitudinal axes coincide and the windings are in the same direction. The outer ends of the coils are connected to the grid and plate respectively. By placing the condenser, C_3 , across the terminals of the plate power supply, the R.F. voltage from the plate to the cathode is by-passed around the power supply. If this condenser were not used there would be a drop in the R.F. potential due to the impedances and resistances present in the power supply. This bypass condenser is large enough to offer little resistance to the R.F. current. The circuit may be used either for receiving or transmitting.

There is a great deal of similarity between all of the basic self-excited oscillators. Just for the sake of comparison, let us study our Armstrong Series-fed Oscillator, Fig. 5, and the series-fed Hartley, Fig. 6. At the first glance, there is no similarity between the two circuits. Now let's return to our Armstrong Oscillator.

We have seen that the grid leak, R_1 , allows C_2 to discharge slowly to ground through L_1 . The same thing may be accomplished by placing the grid leak directly between the grid and ground. Also, since there is no loss of R.F. voltage through C_3 , the lower end of L_1 may be returned to either side of C_3 . By placing this end of L_1 on the positive side of C_3 , a positive potential is impressed on the coil. This voltage is not applied to the tube grid, due to the fact that direct current will not pass through C_2 . Now we can see that since coils L_1 ,

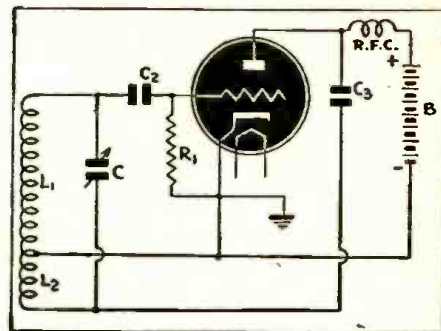

Fig. 7.—Shunt-fed Hartley, another standard circuit.

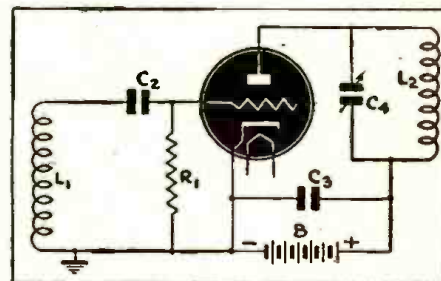

Fig. 8.—The T.N.T., once popular with beginners.

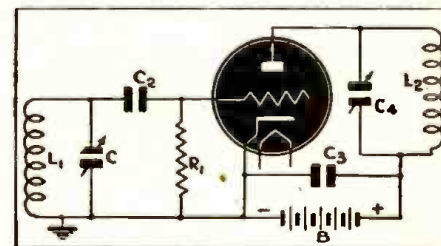

Fig. 8-a.—The tuned-grid-tuned-plate oscillator.

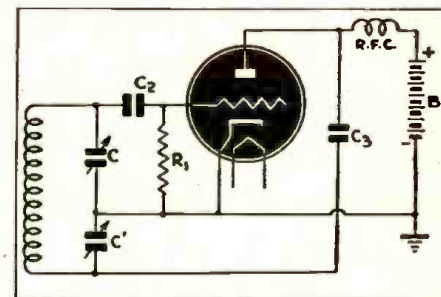

Fig. 9.—The Colpitts circuit, an inside-out Hartley.

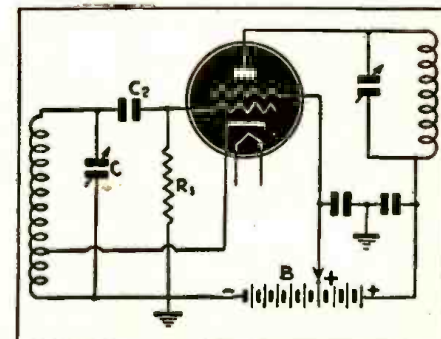

Fig. 10.—Tetrode, or electron-coupled, oscillator.

and L_2 are connected to the same point, the effect would be the same as if the coils L_1 and L_2 were connected in series, with a tap brought out at the point of connection between the two coils. The minor changes that we have made in our oscillator circuit are shown in Fig. 5-a and from this drawing, it is plain that we now have a circuit which is the electrical equivalent of the series-fed Hartley.

PRACTICAL OSCILLATOR CIRCUITS

In the series-fed Hartley circuit, the grid condenser, C_2 , prevents the D.C. voltage from reaching the grid. A high quality condenser with very good insulation must be used for this purpose. A disadvantage of this circuit is that the high voltage is applied to both plates of the tuning condenser, C_1 . This may prove dangerous to the operator when high voltages are used, and is therefore to be avoided if possible.

In order to overcome this danger to tube and operator, the plate circuit may be "shunt fed," that is, the plate voltage fed directly to the plate of the tube through an R.F. choke and a condenser connected between the lower end of the coil and the plate as in Fig. 7. This is the Shunt-fed Hartley Oscillator. The R.F. choke is used to prevent R.F. current from flowing through the power supply. Condenser, C_3 , will allow the R.F. current to flow freely through the lower section of the coil to the cathode. The Armstrong and Hartley circuits were widely used for transmitting and receiving in the early days of radio and are often used now in transmitters and receivers where the frequency must be continuously variable within limits.

Fig. 8 shows a circuit that has come to be known as the T.N.T. oscillator. The grid coil is tuned by its distributed capacity only. It was called the T.N.T. oscillator because with its untuned grid circuit, tuning could never be very sharp, and the plate circuit had to pick out the wanted frequency from among many that might be present on the grid. This circuit was very unstable and responded well to any vibration or shock from external sources.

Unlike the Hartley and Armstrong oscillators, the coupling between plate and grid circuits of the T.N.T. is not made through inductive coupling between the coils. They are coupled by the capacity between the plate and grid. The electrodes of a vacuum tube have the characteristics of a condenser and a change in the potential on one electrode may cause changes on the other. This effect is used to supply feed-back voltages to the grid.

Fig. 8-a is an improvement on the tuned-plate, untuned grid (T.N.T.) oscillator. A condenser is placed in parallel with the grid coil. In this way the ratio between the capacity of the condenser C and grid coil L_1 can be made to order.

We have seen, previously, that the changes in existing capacitance between the plate and grid of a tube—due to temperature variations, etc.—may cause unwanted changes in the characteristics of the grid circuit which lead to instability and erratic operation of the oscillator. By making the capacity of C_1 large in comparison to the tube capacities, the effects of any change in the latter are minimized. The stability of the grid circuit depends upon a large value of capacitance and a low value of inductance.

In the tuned plate and grid circuits just discussed the feedback necessary to cause oscillation is due to the capacitive, instead of inductive, coupling between the input and output circuits.

THE TETRODE OSCILLATOR

In many instances, it is desirable to cancel this coupling. To do this, it is only necessary to place an additional grid between the plate and control-grid. This grid is called the screen and serves as an electrostatic shield between the control grid and plate, neutralizing the plate-to-grid capacitance.

This additional electrode in the vacuum tube also serves to make the plate current independent of the plate voltage. The screen is operated at a positive potential slightly less than, or equal to, the plate voltage. This positive voltage attracts electrons from the cathode and when they have reached the screen, they are pulled through its openings by the plate. The screen, being nearer to the cathode than the plate, serves to accelerate the flow of electrons.

The triode oscillator frequency will vary with the plate voltage. Also the plate voltage will react to load variations. The tetrode, or four element tube is more stable than a triode oscillator in the same type of

ELECTRICITY

For Any Job Anywhere

ONAN ELECTRIC GENERATING PLANTS furnish electricity for all radio work, stationary or mobile, and for emergency service.

They're serving our Armed Forces everywhere in communications work and scores of other war winning tasks.

Ratings, 350 to 35,000 watts. 50 to 800 cycles, 110 to 660 volts, A.C. 6 to 4000 volts, D.C. Also AC—DC models available.

Your inquiry regarding present or past war needs will receive prompt attention. D. W. ONAN & SONS, 728 Royalston Ave., Minneapolis, Minn.

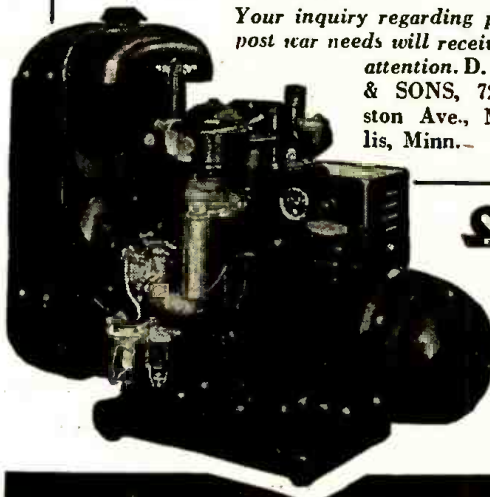

ONAN
ELECTRIC PLANTS



Awarded to each of the four manufacturing Plants of D. W. Onan & Sons.

HALLICRAFTERS ★ HALLICRAFTERS ★

LET'S ALL PITCH IN!

WE CAN all help win this war by selling our government the communications receivers and equipment they need quickly and in sufficient quantities.

That is the reason I pay *highest cash prices* for used communications equipment.

When this war is over you will be in the market for new equipment and by taking advantage of my offer to purchase your present equipment at highest cash prices you will be in a position to buy new and better equipment than you now own.

Write, telephone or telegraph me description of your used communications receivers, transmitters and parts of standard make; you will be paid cash immediately without bother or red tape. I am particularly interested in *Hallcrafters*.

I also have a store at 2335 Westwood Blvd., West Los Angeles, Calif.

Bob Henry, W9ARA
HENRY RADIO SHOP
BUTLER, MISSOURI

COMPLETE STOCKS

I still have large stocks of receivers, 2½ meter equipment, meters, tubes, transformers, resistors, condensers, panels, chassis, and radio parts of all sorts. I sell and rent code teaching equipment. Your orders and inquiries invited.

"WORLD'S LARGEST DISTRIBUTOR OF COMMUNICATIONS RECEIVERS"



10,000

items under one roof

one quick central source
for *Everything* in
Electronics and Radio



FREE!
Send for Today's
Most Up-to-Date
BUYING
GUIDE

**REPAIR and
REPLACEMENT
PARTS
AVAILABLE
without priority**

Save Time . . .
Call **ALLIED First!**

The world's largest
stocks are centralized
in this single arsenal

of supply. Over 10,000 items from all leading manufacturers . . . for the Armed Forces, Radio Training, Research Laboratories, War Industries and Service Replacements. Our experienced staff helps speed delivery. Save time—simplify procurement—call **ALLIED first!** Thousands do.

Write, wire or phone Haymarket 6800.



6 Radio Books for 75c

Dictionary of Radio Terms. No. 37-751 10c
Radio Data Handbook. No. 37-754 25c

Radio Circuit Handbook. No. 37-753 10c
Radio Builders Handbook. No. 37-750 10c

Radio Formulas & Data Book. No. 37-752 10c
Simplified Radio Servicing. No. 37-755 10c

All Six Books No. 37-799 . . . 75c
Write for Quantity Prices

ALLIED RADIO CORP., Dept. 2-M-3
833 W. Jackson Blvd., Chicago, Ill.

Please send following books (..... enclosed)
 FREE 37-750 37-752 37-754
Buying 37-751 37-753 37-755
Guide No. 37-799 (All Six Books)

Name.....
Address.....
City..... State.....

ALLIED RADIO

THE OSCILLATOR—HOW IT OPERATES

(Continued from previous page)

circuit because frequency changes caused by a rise in plate voltage are counter-balanced by frequency changes in the opposite direction due to a rise in screen grid voltage. The action of a tetrode oscillator is further improved by connecting a large by-pass condenser between the screen grid and the ground. This passes the R.F. to ground without a drop in potential and the screen and cathode are at the same R.F. potential.

We have seen how the inductive coupling between the sections of the tank coil of the Hartley oscillator may be used to supply the feedback necessary for oscillations. It has also been shown that capacitive coupling between the grid and plate can be used to sustain oscillation. If the tapped tank of the Hartley circuit is removed and the tuning condenser replaced by a split tank condenser, as in Fig. 9, we have capacitive coupling between the grid and plate. This circuit is known as a Colpitts oscillator and in other respects is fundamentally the same as the Hartley.

One of the most stable self-excited oscillators is the electron-coupled Hartley, employing a tetrode tube. The screen grid serves as the plate of a triode oscillator and the regular plate serves as an amplifier. The electron stream to the plate is controlled by the control grid and the variations of this grid potential control the current flowing in plate tank circuit. By operating the screen at ground R.F. potential, the plate is isolated from the input circuit and the load variations in the plate circuit do not affect the tuning of the grid circuit. This circuit is illustrated in Fig. 10.

The basic fundamentals of the self-excited R.F. oscillators are used in circuits employed in radio receivers and transmitters, wired wireless, diathermy machines, intercommunication equipment and countless other electronic devices.

SELF-EXCITED OSCILLATORS UNSTABLE

The frequency of the oscillations of the circuits discussed, depends directly upon the ratio of the tuning capacitance and the inductance of the tank coils.

The discussion of the resonant frequency

of the coils of a self-excited oscillator, may lead the student to believe that the frequency of an oscillator depends entirely upon the LC ratio in the grid circuit. It is true that the grid circuit is normally the frequency controlling circuit of an oscillator but there are many electrical factors that may lead to changes in frequency and erratic oscillations.

Temperature variations, changes in voltage applied to the plate and other elements, variations in the load, mechanical vibrations and temperature or other changes affecting the resistors, condensers and coils, all play their part. Where strict maintenance of a given frequency is required—as for instance in a modern broadcast station—even the electron-coupled Hartley is not stable enough, and better means of frequency control must be devised. Of these more in a future article.

GEOPHYSICAL PROSPECTING PRINTS (TREASURE FINDERS)

50¢ EACH
7 FOR
\$3.—

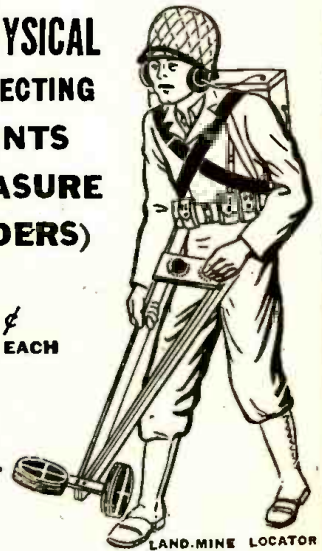

LAND-MINE LOCATOR

With any one of the modern geophysical methods described in the Blue-Print patterns, radio outfits and instruments can be constructed to locate metal and ore deposits (prospecting); finding lost or buried treasures; metal war relics; sea and land mines and "duds"; mineral deposits; subterranean water veins; oil deposits (under certain circumstances); buried gas and water pipes; tools or other metallic objects sunken in water, etc., etc.

Folder No. 1. Radiometer Pilot. Construction and use of 2 tube transmitter and 3 tube receiver. Rectified wave principle. Visual and aural signals.
Folder No. 2. Harmonic Frequency Locator. Radiates low frequency wave to receiver. Aural signals. Visual and aural signals.
Folder No. 3. Boat Note Indicator. 2 oscillators. Visual and aural signals.
Folder No. 4. Radio Balance Surveyor. Balanced loop principle. Modulated transmitter. Visual and aural signals.
Folder No. 5. Variable Inductance Monitor. Inductance principle. Aural signals.
Folder No. 6. Hughes Inductance Balance Explorer. Bridge principle. Aural signals.
Folder No. 7. Radiodyne Prospector. Balanced loop principle. Very large field of penetration. Aural signals.

Each set of blueprints and instructions enclosed in heavy envelope (8 1/2" x 2 1/2") Blueprints 22" x 34"; eight-page illustrated 8 1/2" x 11" folder of instructions and construction data . . . 50c

Add 5c for postage
The complete set of seven folders . . . \$3.00
Shipping weight 2 lbs. (add 25c for shipping anywhere in U.S.A.)

Send Stamps, Cash or Money Order to
TECHNIFAX
RC-1243

1917 S. STATE ST. CHICAGO, ILL.

TECHNIFAX 1917 So. State, Chicago, 16, Ill.

Enclosed herewith \$..... for which mail to address below:

Treasure Finder No. 1. 2. 3. 4. 5. 6. 7.
Complete set of seven folders.

NAME.....

ADDRESS.....

CITY..... STATE.....

RC-1243

HOW TO SERVICE RADIO SPEAKERS

(Continued from page 151)

move the cone. Then lay the speaker on its face on the bench or shop floor, and, using a good-sized hammer and a punch or cylindrical piece of iron as near the size of the pole piece as possible, drive it out—with one blow, if possible. Some pole pieces project slightly through the back of the frame and have been expanded. In such cases they should be ground level before any attempt is made to remove them. The pole piece may be easily re-installed, using a mallet or lead hammer, to avoid damage to that part which will be inside the voice coil. It will practically center itself. The process is shown in Fig. 5.

Certain types of Philco speakers are put together with a special screw with no slot in the head. They look puzzling, but the screw can be driven back out with a hammer and punch. Replace with ordinary bolts and nuts. Some old RCA speakers really were put together to stay, and can be taken apart only with a hack-saw and put together with a welder. If another field coil is available, this job is quite practical. I have even seen cases where the frame was fastened together again with ordinary solder.

TECHNICAL BULLETINS

Technical bulletins give reliable information in easy-to-follow form, and save valuable time otherwise spent in laborious reading of numerous books. Every subject is treated briefly and concisely, yet completely. No complicated mathematics, chemistry, electricity, or theory. Each bulletin is written in simple language.

Each Bulletin consists of a set of large sheets, assembled in one packet, size 9 x 14 1/2"; weight 1/4 lb. Numerous illustrations, diagrams, charts to supplement text.

**PRICE \$1.00 EACH POSTPAID
ORDER BY NUMBER**

- D-111—DESIGNING AND BUILDING TRANSFORMERS
- D-112—DESIGNING ELECTRO-MAGNETS
- D-113—HOW TO DESIGN SOLENOIDS AND PLUNGER MAGNETS
- D-101—USING NICHROME RESISTANCE WIRE
- D-106—REWINDING ELECTRIC MOTORS
- D-144—ALTERNATING CURRENT CONTROLLED WITH EASILY MADE CHOKE COILS
- D-148—DESIGNING AND USING ELECTRIC RELAYS
- D-127—SMALL ELECTRIC LIGHT PLANTS
- D-134—ELECTRICAL EXPERIMENTS WITH SIMPLE MATERIALS
- D-131—MODEL MAKERS & INVENTORS GUIDE TO REMOTE-CONTROL SWITCHING
- D-137—ELECTRICAL METERS EASILY BUILT
- D-136—SMALL A.C. ARC WELDER CONSTRUCTION AND USE

Send Stamps, Cash or Money Order

TECHNIFAX

1917 S. STATE ST. RC-12-43 CHICAGO, 16, ILL.

DEPT RC-12
1917 So. State, Chicago, 16, Ill.

Enclosed find \$..... for which please send me postpaid the following Technical Bulletins:

Nos.

Name

Street and Number

City and State

"Many of the developments of today were the impossibilities of yesterday. Many of the impossibilities of today will be the commonplaces of tomorrow. It is the ability to anticipate the performance of the improbable or the impossible by the other fellow on which professional life depends. There is nothing so surely fatal to industry or its engineers as an attitude of complacent satisfaction toward their products. There is nothing so perishable as an established product. The engineer who says 'it can't be done' is writing the first sentence of his own professional obituary."
(From an address by C. J. Burnside, Westinghouse engineer.)

HOW & WHY MOTORS WORK

(Continued from page 157)

currents flow, are wound around sections of iron. These sections of one member will be made alive-dead-alive again with polarity reversed in a regularly repeated cycle. The sections of the other member will stay alive with polarity unchanged.

The reaction—push-pull—between magnets makes it possible to hold either member still and to let the other member revolve. The effort that makes a motor shaft revolve one way is trying equally hard to revolve the stationary part the other way. Whichever member is free to turn will turn (Fig. 5).

Motors are built with the constant polarity member (i.e., magnetized needle, in the example) either rotating or standing still, or conversely, with the reversing polarity member standing still or rotating. Circumstances of design determine which way it will be.

The poles on the rotating member are kicked along by the poles behind and pulled along by the poles ahead (Fig. 6). As soon as a pole "comes abreast" of the pole that is pulling it, polarity changes and a new set of kicks and pulls are established. The sum total of all the kicks and pulls on all the poles of the rotating member is the turning effort or torque of the motor.

There are strategic times at which to reverse polarities in each revolution (Figs. 7 and 8).

Reversals are effected with time precision in one of two ways. With alternating current, the alternations themselves reverse the polarity of a magnet with each reversal of current flow. The current and hence the poles in one member reverse 120 times per second when the electric system has a frequency of 60 cycles per second.

In direct-current motors the reversals are caused by the revolving member itself through the sequence valving action of the commutator and brushes.

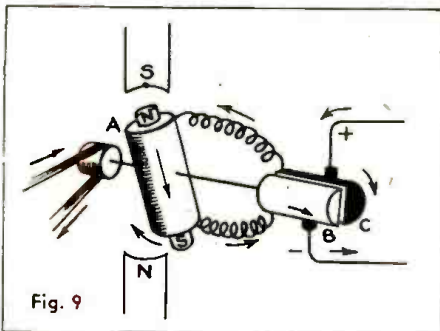

By the time a pole on the rotating member has reached the point of greatest attraction (A in Fig. 9), its polarity is changed because its commutator bars (B-C in Fig. 9) (terminals of the coils) have passed to brushes of opposite sign (B-C in Fig. 10). That is, the bars that were in contact with plus and minus brushes are now in contact with minus and plus brushes and current through the magnetizing coil is reversed. What was a north pole in Fig. 9 is a south pole in Fig. 10.

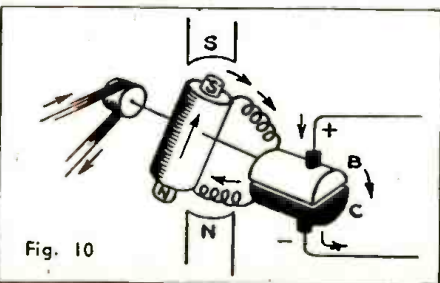

CANADIAN RADIO GROWS

Canada has become a major source of United Nations Supply of intricate radio equipment, according to the Hon. C. D. Howe, Minister of Munitions and Supply, in a statement last month.

Three new industries have been developed in Canada to meet the demands of the radio industry, the output of which has expanded 16-fold since the beginning of the war. They are a dynameter industry, a ceramic insulation industry, and a crystal industry.

Canadian invention is responsible for seven major developments in the production of signals equipment. Ranging from a "talkie-walkie" set which one man can operate as easily as a cradle phone, to a super-highpower field wireless station with a radius of more than 100 miles. These products of original Canadian design have so impressed the United Nations that large orders have been placed in Canada for tens of millions of dollars worth of equipment.

Canada has produced intricate instruments for war purposes to the extent of \$160,000,000 and the 1943 production will reach the \$250,000,000 mark. In the field of instruments and communications the dominion is producing at the rate of 4.3 million a week.

NOW—A REALLY HIGH-POWERED— Radio Engineering Library

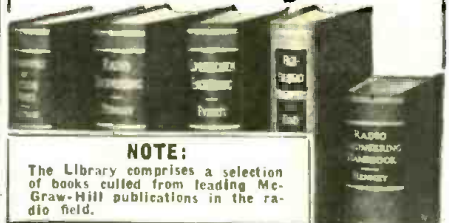

NOTE:
The Library comprises a selection of books culled from leading McGraw-Hill publications in the radio field.

- especially selected by radio specialists of McGraw-Hill publications
- to give most complete, dependable coverage of facts needed by all whose fields are grounded on radio fundamentals
- available at a special price and terms

THESE books cover circuit phenomena, tube theory, networks, measurements, and other subjects—give specialized treatments of all fields of practical design and application. They are books of recognized position in the literature—books you will refer to and be referred to often. If you are a practical designer, researcher or engineer in any field based on radio, you want these books for the help they give in hundreds of problems throughout the whole field of radio engineering.

5 VOLUMES, 3319 PAGES, 2289 ILLUSTRATIONS

1. Eastman's FUNDAMENTALS OF VACUUM TUBES
2. Terman's RADIO ENGINEERING
3. Everitt's COMMUNICATION ENGINEERING
4. Hund's HIGH FREQUENCY MEASUREMENTS
5. Henney's RADIO ENGINEERING HANDBOOK

10 days' examination. Easy terms. Special price under this offer less than books bought separately. Add these standard works to your library now—pay small monthly installments, while you use the books.

10 DAYS' FREE EXAMINATION—SEND COUPON

McGraw-Hill Book Co., 330 W. 42nd St. New York 18
Send me Radio Engineering Library, 5 vols., for 10 days' examination on approval. In 10 days I will send \$3.00 plus few cents postage, and \$3.00 monthly till \$24.00 is paid, or return books postpaid. (We pay postage on orders accompanied by remittance of first installment.)

Name

Address

City and State

Position

Company

RC-12-43

RADIO TUBE HINTS

SYLVANIA SERVICEMAN SERVICE

by
FRANK FAX



SERVICEMEN will find answers they can use every day in "Radio Tube Hints," a 44-page book just published. Not intended as a complete treatise on tubes, this handy easy-to-read volume clears up tube mysteries, explains testing and helps you do your job.

Take a look at the table of contents, reproduced below, and you get an idea of the book's value.

Radio Tube Hints

Table of Contents

	Page
Copper Tube Design Features.....	6
Three Reasons for Blue Glow.....	10
Tuning Indicators Type 6E3 vs Type 6G3.....	17
Tube Mysteries Explained.....	28
Type 35Z5G and Type 35Z5GT Trouble.....	43
Tracking Down Grid Emission.....	50
Tracking Down Grid Short Circuits.....	59
Filament Grid Short Circuits.....	62
Plate and Screen Dissipation Ratings.....	63
Service to Servicemen.....	64

This is the first of a new "Hints" series. Watch for others.

"Tube Hints" is FREE. If your jobber does not have copies in stock, write to: FRANK FAX, SYLVANIA, EMPORIUM, PA.

SYLVANIA

ELECTRIC PRODUCTS INC.

RADIO DIVISION • EMPORIUM, PA.

PUBLIC ADDRESS RELAY SYSTEM

(Continued from page 141)

List of Parts Used in Oscillator and Modulator

- L—Cathode line, 3/8 inch O.D. copper tubing seven inches long
- L—Plate line, 3/8 inch O.D. copper tubing four inches long
- Both cathode and plate lines are spaced 3/4 inch between centers
- L—Copper antenna loop 1 inch wide and 2 inches long
- C—See text
- C—See text
- C—See text
- R—I.R.C. 25,000 ohm. 1 watt resistor
- M—Triplet 0-50 ma. meter
- T—Thordarson small modulation transformer. Hammarlund acorn sockets were used in this oscillator.

Note: In addition to above parts, Johnson insulators were used throughout all three units and Eveready batteries were used to power the transmitter.

List of Parts Used in Receiver Pickup

- ANT—3/4 inch brass roll with sliding sleeve.

- The length can be varied from 15 to 25 inches
- C1—National type M-30 mica condenser
- R1—I.R.C. 5 megohm 1/2 watt resistor
- C2—Cornell-Dubilier .00025 mica condenser
- C3—National type UM, cut down to three plates
- L—No. 6 copper wire bent as shown. 1/2 inch wide and 1 1/4 inches long
- RFC—15 turns No. 20 DCC copper wire, close wound in one layer and bound with collodion
- T—Thordarson T-13A34 transformer
- C4—Sprague 1/2 mfd. paper condenser
- C5—Sprague .1 mfd. paper condenser
- R2—I.R.C. 2500 ohm 1 watt resistor
- R3—I.R.C. 100,000 ohm 1/2 watt resistor
- R4—I.R.C. 1 megohm 1/2 watt resistor
- R5—Electrad 50,000 ohm volume control

List of Parts Used in Speech Amplifier

- C1, C2, C3, C4, C5, C6—Sprague .05 paper condensers
- R1—I.R.C. 3 megohm 1/2 watt resistor
- R2—Electrad 200,000 ohm volume control
- R3, R8—I.R.C. 1 megohm 1/2 watt resistor
- R4, R7—I.R.C. 100,000 ohm 1/2 watt resistor
- R5, R6—I.R.C. 25,000 ohm 1/2 watt resistor

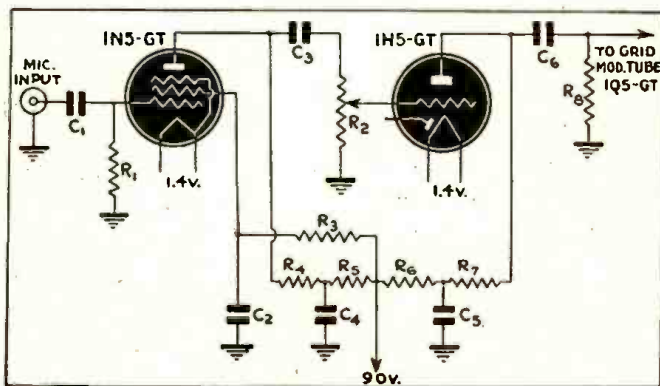

Fig. 3.—The speech amplifier uses a pair of high-amplification tubes to supply sufficient excitation to the grid of the modulator. Diode of the 1H5-GT may be attached to the negative end of the filament or left floating.

SLIDE RULE

(Continued from page 153)

OF THE TWO FACTORS.

- Examples:
- .07 x .55 equals .0385
 - .07 has a minus 1 characteristic, .55 has a zero characteristic. Zero added to a minus 1 equals a minus 1 so the answer has one cipher after the decimal.
 - 6.2 x 41. equals 254.2
 - 6.2 equals 1, 41 equals 2, 1 plus 2 equals 3 so the answer is 254.2 and not 2542. or 25.42 or some other number using the same figures.

SOME RESISTOR PROBLEMS

After a little practice in setting the slide to different numbers and learning the close reading of the numbers we are ready to do any problem in multiplication. Although multiplication will not solve all our service problems without the aid of square root and division it is best to learn its rules first and acquire a familiarity with the slide rule before going into the rest of the operations.

Suppose we want to know if a one watt resistor will be heavy enough to carry 3 Ma. with an applied voltage of 325. P equals ExI so we set the left index of scale C to 3 on D, then under 325 on C we will find 975. The characteristic of 325 is plus 3, .003 (3 Ma.) has a minus 2 characteristic. As the rule projects to the right we use Rule One so 3 added to a minus 2 equals 1, and 1 minus 1 equals zero, thus our answer has a zero characteristic and is .975 watts. A one watt resistor would allow no margin for safety, so we use a 2-watt resistor.

To determine which way to set the slide is no problem at all. You will find that if you set the left index of scale C to a number on D (in multiplication) and the other

number is off the scale simply reverse the procedure and use the right hand index of scale C.

DIVISION AND SQUARE ROOTS

Division is the reverse of multiplication. To illustrate we will divide 8 by 4. Set the 4 on scale C to the 8 on scale D, then under the left index of C will be found the answer, 2. The divisor is found on scale C and placed in line with the dividend on D, then the quotient is found below the index of C that is not projecting beyond the rule.

To divide 8 by 9 the 9 is found on C and placed over the 8 on D and under the right index of C will be found the answer, .889. To reverse this and divide 9 by 8, the 8 is found on C and put in line with the 9 on D, then under the left index of C will be the answer, 1.125. The rules for placement of the decimal point are just as simple as are those of multiplication.

RULE THREE:

WHEN THE SLIDE PROJECTS TO THE LEFT IN DIVISION, THE CHARACTERISTIC OF THE QUOTIENT EQUALS THE CHARACTERISTIC OF THE DIVIDEND MINUS THAT OF THE DIVISOR.

RULE FOUR:

WHEN THE SLIDE PROJECTS TO THE RIGHT, THE CHARACTERISTIC OF THE QUOTIENT EQUALS THE CHARACTERISTIC OF THE DIVIDEND MINUS THAT OF THE DIVISOR PLUS 1.

In the above examples 9 divided by 8 illustrates Rule Four and 8 divided by 9 illustrates Rule Three.

Now that we can both multiply and divide the slide rule becomes really useful,

even without square root. To illustrate with a few examples:

We want to know what resistance is needed to bias a tube. The required voltage is —16.5 and the rated cathode current is 12 Ma. The formula for this is:

$$R \text{ equals } \frac{\text{Bias volts} \times 1,000}{\text{Rated cathode Ma.}}$$

16.5 x 1,000 equals 16,500, we find this on scale D as it is the dividend. The small figures between the 1 and 2 are used. Over this place the 12 on C, then under the left index will be found 1375. As the slide projected to the right we use rule four which, in this case, gives a characteristic of 4, so the required resistor is one of 1375 ohms.

Suppose we have a 25000 ohm resistor and wish to put another one in parallel so that the effective resistance will be 8500. The formula for this is:

$$R2 \text{ equals } \frac{R1 \times Rt}{R1 - Rt}$$

Rt is the multiplier so we set the right index of C to 85 on D, then move the indicator until it is on the 25 mark on C, the hair line will pass through 2125 on D. Do not move the hair line. This is now the dividend, the divisor (R1) is 25000 less (RT) 8500, or 16500 which we find on C and place it under the hair line to correspond with the 2125 mark on D. Then under the left index of C we will find 1289 (1300 would be close enough, or 1250, for practical use).

The slide projected to the left in the multiplication which gave a characteristic of 9 (Rule Two); in the division the slide was to the right so by Rule Four the characteristic of the quotient is equal to that of the dividend, minus that of the divisor, plus 1. The dividend had 9, the divisor (16500) had 5; 9 minus 5 leaves 4, and adding 1 makes 5, so the answer 1289 needs a cipher to make it 12,890 ohms (or 12,500).

EASIER THAN IT SOUNDS

It takes a good deal more time to explain this than it does to do it. With a little practice, a problem like this may be solved in twenty seconds.

When a problem involves both multiplication and division, as did the last one, the intermediate answer need not be read, just mark it with the hair line and note its characteristic, then continue with the division.

The same method is used in figuring series condensers. While in the above example we could have placed the decimal point from experience, it will be found considerably harder to do with series condensers if they are far apart in values. Let us take two condensers and see how it works out.

$$Ct \text{ equals } \frac{C1 \times C2}{C1 + C2}$$

Let C1 be 2.mfd. and C2 be .004 mfd. C1 x C2 equals .008.

The left index of C is set to the 2 on D and under 4 on C will be found 8 on D. The slide projected to the right so the characteristic will be minus 2 (.008). Set the hair line to this and run the slide back until 2.004 (C1 plus C2) lines up with the indicator, then under the left index of C will be found 3994. By Rule Four the characteristic will be minus 2 making the answer .003994. Notice should be taken that the 2.004 mark is not quite half way between the 2 and the very first division line following it. Setting and reading these close approximations should be practiced and the results checked with paper and pencil until you are sure of your skill.

HARD-TO-GET ITEMS

The war has made a terrific inroad in practically all electrical and mechanical supplies. We are fortunate in being able to offer difficult to obtain merchandise listed below. As supplies are limited, we suggest that you order immediately before certain of the items are sold out. All of the attractive items listed here are brand new, except where indicated. All are in PERFECT WORKING ORDER. In many cases, the parts alone total more than the price we are asking. Satisfaction guaranteed or your money back. ORDER FROM THIS PAGE. Use our convenient coupon. Include sufficient extra remittance for parcel post charges, otherwise order is sent express collect. Any excess will be refunded. All C.O.D. shipments require 20% deposit. NO C.O.D. shipments on orders for less than \$3.00. If full remittance accompanies order, deduct 2% discount. Send money order, certified check, or new U. S. stamps. No C. O. D.'s to foreign countries.

ORDER TODAY LIMITED QUANTITIES PROMPT SHIPMENTS ASSURED

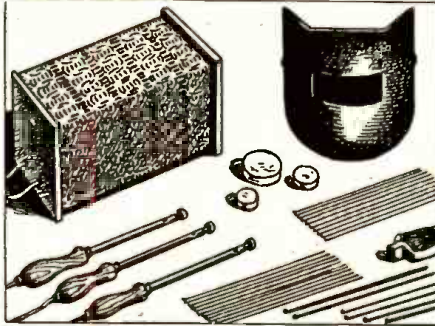

THE MAGIC ELECTRIC WELDER

Here is one of the most compact, practical welders we have ever seen. Anyone can use it for shop, farm and home repairs. WELDS, BRAZES, SOLDERS, CUTS ALL METALS. ANYONE CAN OPERATE IT. Repairs steel, cast iron, aluminum, brass, copper, bronze, etc. Complete with power unit, flame and jettable arc attachment. Really two welders in one! Carbons, fluxes, rods, mask included. Just plug it in any electric outlet. 110 volts AC or DC. For hobbyist or professional. GET IN ON THE GREAT WELDING BOOM. This fine set quickly teaches you welding. Low cost to operate—about 5c an hour. COMPLETE SAFETY is assured. No fumes with this outfit. SET COMES COMPLETE—nothing else to buy. Used by the U. S. Navy, American Tel. & Tel. Co., Eastman Kodak Co., Bell Laboratories, etc. BRAND NEW OUTFIT. Guaranteed for one year. Complete simple instructions with each set. ITEM NO. 128 YOUR PRICE **\$19.95**

WESTERN ELECTRIC BREAST MIKE

This is a fine light-weight electric carbon microphone. It weighs only 1 lb. Mike comes with breast-plate mounting and has 2-way swiveling adjustment so that it can be adjusted to any desired position. There are 2 woven straps one goes around neck, the other around chest. Straps can be snapped on and off quickly by an ingenious arrangement. This excellent mike can be adapted for home broadcasting or private communication systems. By dismounting breastplate, it can be used as a desk mike. Comes complete with 6-foot cord and hard rubber plug. Finished in anoradized plate, non-rustable. THIS IS A BRAND NEW MIKE. IT HAS NEVER BEEN SOLD AT SUCH A LOW PRICE BEFORE. ORIGINAL LIST PRICE \$15.00. Shipping weight, 2 lbs. ITEM NO. 132 YOUR PRICE **\$2.55**

POWERFUL ALL-PURPOSE INDUCTION MOTOR

Sturdily constructed to precision standards, this self-starting reversible shaded pole A.C. induction motor is powerful enough for a number of uses. Some of these are: Automatic Timing Devices, Current Interrupters, Electric Fans, Electric Chimes, Window Displays, Photoelectric Control Devices, Electric Vibrators, Small Grinders, Buffers and Polishers, Miniature Pumps, Mechanical Models, Sirens, and other applications. Consumes about 15 watts of power and has a speed of 3,000 r.p.m. When geared down, this sturdy unit will constantly operate an 18-inch turntable loaded with 200 lbs. dead weight—THAT'S POWER! Dimensions: 8" high by 2" wide by 1 3/4" deep; has 4 convenient mounting studs; shaft is 3/8" long by 3/16" diameter, and runs in self-aligning oil-retaining bearings. Designed for 110-200 volts, 50-60 cycles. A.C. only. ITEM NO. 147 YOUR PRICE **\$1.95**

HUDSON SPECIALTIES CO., 40 West Broadway, N. Y. C.

IT'S EASY TO ORDER—CLIP COUPON—MAIL NOW ORDER FROM THIS PAGE.

HUDSON SPECIALTIES CO., 40 West Broadway, Dept. RC-12-43, New York, N. Y.

I have circled below the numbers of the items I'm ordering. My full remittance of \$_____ (include shipping charges) is enclosed. NO C.O.D. ORDERS UNLESS ACCOMPANIED WITH A DEPOSIT. (Include OR my deposit of \$_____ is enclosed (20% required), ship order C.O.D. for balance. NO C.O.D. ORDER FOR LESS THAN \$3.00. (New U. S. stamps, check or money order accepted.)

Circle Item No. wanted: 33 87 147 152 153 157 168 169

Name _____ Address _____

City _____ State _____

Send remittance by check, stamps or money order; register letter if you send cash or stamps.

ULTRA MAGNET

LIFTS MORE THAN 20 TIMES ITS OWN WEIGHT

LITTLE GIANT MAGNET. Lifts 5 lbs. easily. Weighs 4 oz. Made of ALNICO new high-magnetic steel. Complete with keeper. World's most powerful magnet ever made. The experimenter and hobbyist will find hundreds of excellent uses for this high quality permanent magnet. Measures 1 1/2" x 1 1/2". Shp. Wt. 3/4 lbs.

ITEM NO. 159 YOUR PRICE **\$1.25**

VARIABLE SPEED UNIVERSAL MOTOR

For 110 Volts, A.C. or D.C. All Nickel Plate

Edison Dictaphone motor 1/50 H. P. Used but in excellent condition. For buffing, polishing, drilling, sawing, runs phonographs, fans, models, blowers, lathes, etc. Special control permits variable speeds up to 1500 r.p.m. 5/16" shaft extends from both sides of motor. Cast iron base has 3 screw mounting holes. long on one side. Shp. wt. 8 lbs.

Height 4 1/2", length 7 1/2", width 5 1/2". Shaft is 1 1/4" diameter.

ITEM NO. 157 YOUR PRICE **\$3.45**

POWER ADJUSTABLE RHEOSTAT

Here is an excellent rheostat used especially to regulate speeds of small motors, such as our Handy Workshop Outfit. This rheostat can be used in connection with motors up to 1/20 h.p.

This fine rheostat is wire-wound on porcelain insulation. The black enamel steel casing is perforated for ventilation. Adjustable handle regulates speed of motor easily and smoothly. Size 8"x2 3/4" overall. Shp. Wt. 2 lbs.

ITEM NO. 153 YOUR PRICE **\$1.45**

AMAZING BLACK LIGHT!

Powerful 250-Watt Ultra-Violet Source

The best and most practical source of ultra-violet light for general experimental and entertainment use. Makes all fluorescent substances brilliantly luminescent. No transformers of any kind needed. Fits any standard lamp socket. Made with special filter glass permitting only ultra-violet rays to come through. Shows out beautiful opalescent hues in various types of materials. Swell for amateur parties, plays, etc. to obtain unique lighting effects. Bulb only. Shp. wt. 1 lb.

ITEM NO. 87 YOUR PRICE **\$2.45**

WATTHOUR METER

Completely overhauled and ready for immediate service. Designed for regular 110-volt, 60 cycle 2-wire A.C. circuit. Servicemen use it in their shops to check current consumption of sets, soldering irons, etc. Keeps costs down. If dismantled, the parts alone would bring the price. The elaborate gear train could be used as a counter on machines of various kinds. Simple to install: 2 wires from the line and 2 wires to the load. Sturdily constructed in heavy metal case. 8 1/2" high, 6 1/2" wide, 3" deep. Vestinghouse, E. or Ft. Wayne makes. Shp. Wt. 14 lbs.

ITEM NO. 33 YOUR PRICE **\$4.95**

ENGINEERS

**NATIONAL UNION
OFFERS A GREAT
OPPORTUNITY**

National Union Radio Corporation, long acknowledged as a national leader in vacuum tube manufacture, is building a greater research and engineering staff. Our contribution to the war effort has been substantial; our plan for the future knows no bounds. If you get into this electronic tube picture now, you have a brilliant future, unlimited horizons ahead.

Our laboratories are in Newark, New Jersey.

We prefer men with a degree in electrical engineering, physics or mathematics and a knowledge of vacuum tubes; however, if your experience warrants, a degree is not absolutely essential. You must be draft exempt and not now employed full time at highest skill in a war industry.

CAN YOU QUALIFY AS:

- Electronic tube engineer
- Metallurgist
- Production engineer
- Development engineer
- Measurement engineer
- Physicist
- Electrical engineer

Write at once and tell us your experience, education, draft status, salary requirements.

**NATIONAL UNION
RADIO CORPORATION**

48 Spring St., Newark, New Jersey



**TECHNICAL
PERSONNEL
WANTED**



WESTERN ELECTRIC CO.

In PEACE
Source of supply for the
Bell System
In WAR
Arsenal of communication
equipment

NEEDS

ELECTRICAL TESTERS

MEN AND WOMEN

For Radio Transmitters & Receivers & similar equipment.

Young men and women who have been licensed radio amateurs preferred or those having a good technical knowledge of voice communication and trained in electrical testing of radio equipment are needed for inspectors and testers.

Release statement and U.S.E.S. consent needed.

**WRITE OR APPLY TO
C.R.L., DEPT. 4816**

**100 Central Ave.
Kearney, N.J.**

Mon. through Sat. 8:30 a.m.-5:00 p.m.

ENGINEERS DESIGNERS

**ELECTRICAL, MECHANICAL,
RADIO, ACOUSTICAL**

For Research and Development Laboratory of large company fully engaged in war work manufacturing aircraft accessories. Activity includes electronic control equipment, continuous recorders, special radio devices, etc.

Excellent post-war opportunities. Laboratory located in central Manhattan. All replies strictly confidential. Write full details. Box 752 Equity, 113 W. 42nd St., N. Y. C.

A forecast of FM and television networks in the post-war world, short-wave FM stations now link up points as far apart as New York, Schenectady, and Mt. Washington.

IF YOU want to "let yourself go," in a new and revolutionary electronic field

IF YOU are right at home in UHF and Television.

IF YOUR present work cramps your style, ingenuity or opportunity and if your full talents are not 100% for war THEN

COME WITH US

We are carrying the ball in a scientific battle against the enemy. We need competent research engineers. Outline your education, experience, marital status and salary requirements.

Address:

PANORAMIC RADIO CORP.
245 W. 55TH ST. NEW YORK 19, N. Y.

Unity in Post-War Program Is Goal of the New R.T.P.B.

A UNIFIED approach to post-war problems on the part of the whole radio-electronics industry is the aim of the recently-organized Radio Technical Planning Board, according to a statement issued last month by Hararden Pratt, chairman of the new Board's publicity committee.

Objectives of the Board, as expressed in the statement, shall be to formulate plans for the technical future of the radio industry and services, including frequency allocations and systems standardization, in accordance with the public interest and the technical facts, and to advise Government, Industry, and the Public of its recommendations. Such planning shall be restricted to engineering considerations.

Thirteen Panels, each for the study of some specific radio problem, have already been set up. These cover Spectrum Utilization, Frequency Allocations, High Frequency Generation, Standard Broadcasting, VHF Broadcasting, Television, Facsimile, Communications, Relay Systems, Radio Range, Direction and Recognition, Aeronautical Radio, Industrial, Medical and Scientific Equipment and Police and Emergency Service.

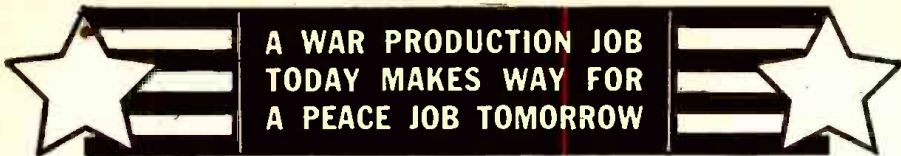

WESTERN ELECTRIC CO.

In PEACE
Source of supply for the
Bell System
In WAR
Arsenal of communication
equipment

NEEDS INSPECTION ENGINEERS

For quality
control work.

Men or Women

Background required: Knowledge of D.C., A.C. and electronic theory. High school with some college background in Physics and Mathematics or radio school essential. Experience in amateur radio with license desirable but not required.

To do inspection and testing of radio and other high-frequency equipment.

Release statement and U.S.E.S. consent needed

Write or apply in person to A.C.C., Employment Dept.

100 Central Ave.
Kearny, N. J.

Monday through Saturday
8:30 A.M. to 5 P.M.

ELECTRONICS AND THE PUBLIC

(Continued from page 133)

Other popular writers in the daily press talk much along the same lines. In a syndicated column of a Chicago newspaper, Robert M. Yoder, discussing the FORTUNE article, voices as his opinion: "It isn't through any love for opening garage doors by hand, that the citizens haven't adopted the electric eye. It isn't through any love of burglary that they don't buy the finest electric eye burglar alarms. It is because conveniences like these are priced for the carriage trade, and when I say 'carriage' trade I mean a cabin cruiser." The point made here is that practically all of the electronic devices are at present out of reach of the average citizen. They rightfully figure that if you could buy the best electronic burglar alarm for \$5.00; and a good garage door opener for perhaps \$20.00, there would be a huge market for them.

To get down to brass tacks, if electronics is to be as popular as it deserves to be, in the post-war period, electronic appliances

and devices must be manufactured on a mass production basis.

There was a time when an older electronic device—the radio receiver—sold originally for \$150.00 a set, or thereabouts. On account of the novelty of radio, which took the public's fancy, it is true that even at this price hundreds of thousands of sets were sold—helped by installment plan buying. But radio really got under way when the average set came down to a price of less than \$50.00; then the sales went into the millions.

Some of the progressive manufacturers have already seen the light and have laid plans for immediate mass production of electronic devices hitherto out-of-reach of many people. To name only one—the public-spirited action of Commander E. F. MacDonald, Jr., President of the Zenith Radio Corporation, should be shouted from the housetops. Heretofore a good hearing device cost anywhere from \$100 to \$150, simply because it was made for the carriage trade, but not for the unfortunates who could not afford to pay such a price, and who had to borrow, beg or steal to get the necessary money together, if they were partly deaf. Commander MacDonald is changing all this by making and selling the self-same article—which may even be better than present day hearing devices—for \$40.00—not tomorrow, not in the post-war period, *but right now, TODAY*. At that price it is certain that millions will be able to buy hearing devices in the very near future.

Other electronic devices which are not of such urgent necessity to the average citizen must be sold in a different manner. The public first must be made to want them and then if the device is put into mass production, in time the public will buy it. It should always be kept in mind that for years to come many new electronic devices will have a certain amount of sales resistance which must be overcome. This means that the householder must be educated to the merits of the device and why it will improve his house or his apartment.

But let us not forget that there are two distinct types of electronics. In fact, it might be an excellent idea to advertise industrial electronic devices only through trade papers. Ultimately if such a plan were adopted, it would facilitate the householder in adopting the marvels of electronics into his home.

The other day, with a deep breath, we made up an itemized and geographical list of all FM activity for a researcher who's conducting a survey of broadcasting and its potentialities in this country. He wants to find out, you see, just where FM interest is centered and maybe talk to some of the groups that either have FM transmitters on the air or plan to build them after the war.

We ended up with quite a stack of data. In addition to the 50 stations now operating in 15 different states (but heard regularly in a total of 24), we could also muster about 76 proposed FM outlets in some 30 states. There must be others. As a matter of fact, we're sure there are others because, according to a recent survey by the General Electric Co., a total of 144 AM stations plan to file applications for FM transmitters as soon as the war ends or maybe before.—*FM Broadcasters*

WANTED

For the

PHILCO ENGINEERING STAFF

- **RADIO TECHNICIANS**
Ham operators and radio service men familiar with test equipment.
- **RADIO-ELECTRONICS-ELECTRICAL ENGINEERS**
Men with degrees in electrical engineering or comparable experience in radio and television.
- **MECHANICAL ENGINEERS**
Men with college degrees or comparable experience in the engineering aspects of electrical appliances, and in designing small machinery.
- **DESIGN ENGINEERS — DRAFTSMEN**
Men with experience in mechanical designing, especially of small metal parts and of the automatic machinery to mass-produce them.
- **MODEL MAKERS**
First class precision workers and all-round mechanics capable of starting with blueprints, making the parts required and assembling the finished models.

WE expect the men who qualify for these positions to become permanent members of our staff and take an important part in our post-war program.

To maintain the Philco tradition of progressive research and development, is first and foremost in our minds. In such an atmosphere of encouragement most engineers find they do their best work. To aid them, we provide the finest of technical equipment. But often, even more helpful is the inspiration and personal assistance they gain here at Philco in working with men who have done so much for the advancement of Radio, Television, Refrigeration and Air-Conditioning.

WRITE US TODAY

Qualified men not now engaged in work requiring their full talents, are invited to write us in detail as to their experience, education, family and draft status, and salary. Letters will be treated in strict confidence.

Hiring subject to local W. M. C. rulings.

WRITE TO MR. GEORGE DALE

PHILCO CORPORATION

Philadelphia 34, Penna.

The Mail Bag

A FULL-TIME SERVICEMAN'S VIEWS

Dear Editor:

In the August issue of *Radio-Craft*, "An Army Private" takes issue with Fred Shunaman on the subject of repairs of radio receivers in the customers' homes.

In my opinion he disqualified himself as an authority on the subject in the third paragraph of his letter. He states: "Radio has always been my hobby, and while working for various manufacturers, I put in some part time going around to repair other peoples' radios. . . ."

Had he been a full-time serviceman in civilian life, he would have a different slant on this subject. There are countless reasons why I do not service broken radios in the home (other than simple jobs like tube replacements, etc.), but I have yet to find one good reason why the radio should be repaired in the customer's home.

I have expressed myself freely on this subject in previous letters and my attitude is still unchanged.

Another old subject has been brought up

by "An Army Private" with reference to the boys who will come out of the Signal Corps with "additional knowledge and certificates to prove it." If he means the fellows who were servicemen before entering the service, I agree with him, but if he means those who have their radio training in only the military field, my answer is, no! It is not my desire to get into an argument with these men as to the merits of their training, as they have been well trained for the job they were doing and are doing the job well, but I think most of them will agree they have much to learn before they can make a living servicing civilian radios.

To all those fellows who are thinking of taking up servicing after their return to a civilian status I want to say: "Come on, fellows, glad to have you, but for Pete sake don't do anything that will lower the business any more, but help us old-timers to lift it up to a standing as a profession."

E. M. PACE,
Pace's Radio Service,
Vicksburg, Miss.

COMPLETE SCHEMATICS ARE BETTER

Dear Editor:

I am what you might call the average reader of your magazine and became a subscriber because I wanted to learn more about radio and electronics. For the most part, I have gained a great deal from the circuits, diagrams and descriptions contained therein but now and then feel disappointed when some writer does not furnish at least a key schematic to convey to the average reader the gist of the subject he is covering.

I have read schematics covering telephone circuits for years and can usually grasp the writer's meaning without thoroughly reading the article. But when you have to look over a group of schematics and try to fit some of them together it is pretty much of an effort.

Take for example, the article Wired Wireless, appearing on page 656 of your August issue. This is a splendid subject and I wanted to understand it fully. If there had

been a schematic starting at the mike and ending at the line circuit the article would be easier to grasp by readers like me. On the other hand, the Barbed Wire Telephone appearing on page 736 of your September issue is clear enough because one can start at the telephone transmitter and follow through to the line. It would have been plain enough if only a pair of terminals had been used marked "to the line circuit" instead of showing the telephone line.

I know enough about Wired Wireless to understand its purpose and still would like to see a schematic starting at the telephone transmitter and ending at the line. If it takes more than one drawing these should be so drawn that you could carry through from one to the other as a means of clear identification. I trust that you will kindly take this as a suggestion and not as a complaint.

CLARENCE A. ANDERSON,
San Diego, Calif.

THE LISTENING POST IS APPRECIATED

Dear Editor:

I have just been looking through the May 1943 issue of *Radio-Craft*, which I borrowed from an SWL friend and saw your department *The Listening Post*. That is something which is sorely needed in most radio magazines today. I don't know whether you continue to carry this column in your excellent magazine. If you do continue it as a regular feature, you will certainly find in me at least one interested and enthusiastic reader.

I do not see why it would be necessary to discontinue this department during the war, for it would aid greatly in SWL'ing. Most of us do not have time to cover the

dial looking for DX, and this department gives assistance in locating it.

Of course, most QSL'ing is out for the duration, but a well-kept log listing such items as time, date, call, location, signal strength, etc., would come in very handy.

My receiver is an Echophone EC-1 with six tubes, and I've really pulled in a bit of DX; though at present it's laid up for lack of a 12K8 tube. However, the local serviceman seems to think he will be able to obtain one for me. Until he does, though, I'm really lost.

IVAN MERTES, LSPH,
Bridgeport, Indiana

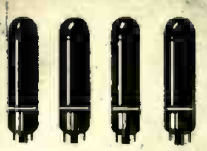

4 STANDARD TYPES
of Amperite Regulators replace over 400 types of AC-DC Ballast Tubes now in use.

Amperites are real REGULATORS. . . have patented Automatic Starting Resistor which prevents initial surge and saves pilot lights. . . Ask Your Jobber.

AMPERITE

THE *Simplest* WAY TO REPLACE BALLASTS

WRITE FOR REPLACEMENT CHART

AMPERITE Co. 541 BROADWAY, NEW YORK, N. Y.



HIGH EFFICIENCY results in Sound National Defense that is why NATIONAL DEFENSE SOUND SYSTEMS are equipped with University Reflex HIGH POWER LOUSPEAKERS UNIVERSITY LABS. 225 VARICK ST. N.Y.C.

University

OPPORTUNITY AD-LETS

Advertisements in this section cost 20 cents a word for each insertion. Name, address, and initials must be included at the above rate. Cash should accompany all classified advertisements unless placed by an accredited advertising agency. No advertisement for less than ten words accepted. Ten percent discount six issues, twenty percent for twelve issues. Objectionable or misleading advertisements not accepted. Advertisements for January, 1944, issue must reach us not later than December 18, 1943.

Radio-Craft • 25 W. B'way • New York 7, N. Y.

RADIO SERVICEMEN AND EXPERIMENTERS SEND for our giant radio catalog. Save dollars. United Radio Co., (1000P) Newark, N. J.

USED CORRESPONDENCE COURSES AND TECHNICAL Books Bought, Sold, Rented. Catalog Free. Educational Exchange, Henager, Alabama.

HELP WANTED: EXPERIENCED RADIO service man. Permanent position, good salary. Write L. E. Munroe, 111 Shelby St. Kingsport, Tenn.

WANTED TO BUY: MILLIAMPER METERS, 0 to 1 mill or 0 to 50 micro-amperes. Write L. E. Munroe, 111 Shelby St., Kingsport, Tenn.

SECRET SUBSTITUTES: 35Z5, 12SQ7, 5016, 1A7, 1L5. J. English, 2127 Pacific, Spokane, Wash.

A kite string of glass yarn is used with the box kite that carries aloft the antenna of the "Gibson Girl" portable, hand-generator, radio transmitter developed by the Army Air Forces to summon help for fliers forced to make crash landings at sea.

Glass yarn is used as the kite string because of its great strength in proportion to its weight.

PILOT MINE DESTROYERS

(Continued from page 138)

save valuable lives, but, more important, that the pursuing army can now travel at full speed, and in this manner can prevent the enemy, once the movement gets under way from burying new mines. When a pursuing army is stopped or can only advance slowly, the enemy gains time and can plant mines at his leisure. Where the advancing army pursues at the rate of 40 or 50 miles, day and night, the retreating army will not have much time or chance to bury mines. Land mines may therefore come into disuse if the scheme which I advocate is adopted.

Let us now see how the plan works out in practice during actual warfare. An Allied Army at a given moment begins to advance against the enemy. From four to ten pilot tanks are traveling abreast in the vanguard. A little distance behind them we have a large well-armed tank which must be well-armed because it will surely draw the enemy's fire. This first tank is the control vehicle that transmits radio impulses to the pilot tanks in front of it. The pilots presently reach a belt of land mines which now begin to blow up. Two, three or more of the pilot tanks may thus be blown up, destroyed or damaged. They are disregarded because they have done the work allotted to them and it enables the army to roll on at full speed. Should several of the wrecked pilot tanks obstruct the road, a special clearing crew in the rear immediately advances and clears them out of the way. Remember, the tanklets do not weigh very much and the road will therefore be cleared within minutes. Reserve pilot tanks replacing the ones blown up, follow immediately, and the pursuing army can speed on practically without stopping, or at least only slowing down.

In the very nature of things, only certain areas can be mined. It never happens that an entire road over its entire length can, or will be mined, because it would take hundreds of thousands of mines, and the time element to plant them is also against it. Land mines, as a rule, are therefore only sowed in belts, but never over any great distance. Consequently, one belt cleared, the pursuing army will not be stopped for very long—it may slow down but it won't stop.

It is, of course, possible for the retreating army to pepper the pilot tanks with artillery. That is true, but remember that they are very small and are thus hard to hit; certainly much harder than a big tank. It is also possible for the enemy to bomb the little pilot, as indeed the enemy now bombs regular tanks too. The answer to this is that the pursuing army must have an air force sufficiently powerful, thus preventing the enemy from successfully bombing the advancing column. It is quite true that enemy artillery fire may put a few pilot tanks out of business, which is to be expected. More serious is enemy fire directed against the radio-control tank which carries the crew, that radio-directs the pilots. For that reason there will always be more than one control tank in the rear, so that in case one is disabled, the other switches on its radio power and carries on.

It might be thought that the enemy could easily jam the radio transmitting signals which control the pilots. That, however, is not such an easy matter as one would first imagine. Indeed, it is almost impossible to do it unless the enemy has the "key." In the November issue of *Radio-Craft* I went at considerable length to describe the high complexity of modern tele-radio-control (in my article on the radio-controlled glider bomb which the Nazis are now using against allied shipping.)

(Continued on following page)

FADA

FACTORY SERVICE DEPT.
OFFERS you a completely equipped service organization to handle your repairs on Fada and all other make radios

FADA OF NEW YORK

928 Broadway, New York, N. Y.
Tel.: GRamercy 7-0951-2 and 0980

LARGE STOCK OF REPLACE-
MENTS AND CABINETS
ALWAYS ON HAND

LEARN CODE the way you'll be using it by SOUND



The best way to learn to read code is by listening to code. The best way to learn to send code is by hearing your own sending repeated back to you. With the new All-Electric Master Teleplex Code Teaching Machine, you learn code the natural, easy, fascinating way. Only instrument ever produced which records your sending in visible dots and dashes—then SENDS BACK your own key work at any speed you desire. There are NO PERFORATIONS—NO INK. Far superior to anything ever developed. A marvel of simplicity. That's why practically every school teaching code uses TELEPLEX. We furnish complete course, including the All-Electric Master Teleplex. Give your personal instruction with a MONEY BACK GUARANTEE—all at a surprisingly low cost. Write today for FREE catalog 512. No obligations.

107 HUDSON ST.
TELEPLEX CO., JERSEY CITY, N. J.

SUBSCRIBE NOW TO—

AND RECEIVE FREE THIS DICTIONARY

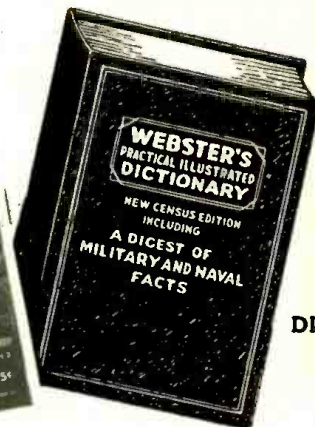
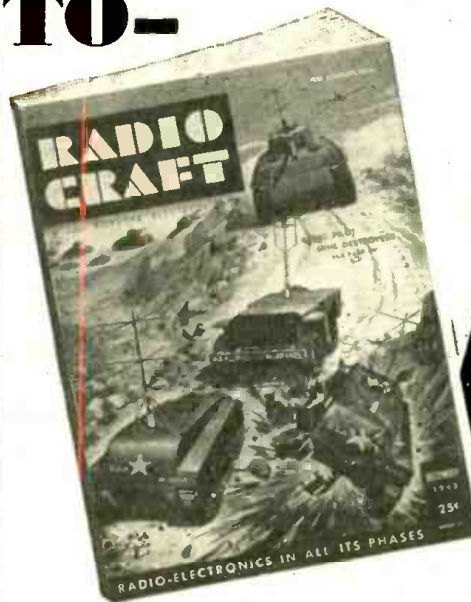

FULL
LIBRARY
SIZE
WEBSTER
DICTIONARY
378
PAGES

FIVE MONTHS \$1.00

TWELVE MONTHS \$2.00

SPECIAL NOTICE TO OUR READERS

Due to wartime curtailment of paper, we are unable to meet the increasing newsstand demand for **RADIO-CRAFT**. We are therefore making this special introductory offer to our readers. Assure yourself of getting a copy of **RADIO-CRAFT** monthly by subscribing now and at the same time co-operate in making this wartime measure effective. Don't delay—Send in your order today. Take advantage of our special long-term offer and protect yourself against any possible increase in price by sending \$2.00 for 12 issues.

If you will take advantage NOW of our special subscription offer of five months for \$1.00 or twelve months for \$2.00, we will send you **ABSOLUTELY FREE** and **POSTPAID** this 378-page **WEBSTER'S PRACTICAL ILLUSTRATED DICTIONARY**—useful and instructive to all. This self-pronouncing authoritative dictionary—a brand new work throughout—contains the most up-to-date words now in common use. Over 20,000 definitions in all. In addition, it has the following: List of Largest Cities in the U. S.; List of Principal Cities of the U. S.; List of Principal Cities of Canada; National Parks of the U. S.; Time and its Variations; Tables of Weights and Measures; Presidents of the U. S.; Synonyms and Antonyms; Dictionary of Commerce and Law; Dictionary of Forms of Address; Military and Naval Information (illustrated); Digest of the Purposes of Current Federal Agencies.

THIS IS A TIME LIMITED OFFER

MAIL COUPON

TODAY FOR A
SUBSCRIPTION

AND DICTIONARY

RADIO-CRAFT

25 WEST BROADWAY
NEW YORK 7, N. Y.

RADIO-CRAFT DEPT. 12-43,
25 WEST BROADWAY, NEW YORK 7, N. Y.

Gentlemen: Enclosed you will find my remittance for which enter my subscription to **RADIO-CRAFT** Magazine for the period checked below. Send me **ABSOLUTELY FREE** and **POSTPAID** the Webster Dictionary.

5 months — \$1.00 12 months — \$2.00
 This is a new order Renewal

NAME _____ Please Print Clearly

ADDRESS _____

CITY _____ Postal (if) _____ STATE _____
Dist. No. (any)

Remit by check or money order; register letter if you send cash or unused U. S. Postage Stamps. (Canadian and foreign orders must be accompanied by an International Money Order.) On Canadian orders add 50c for postage; on foreign add 75c for one year.

VIBRATOR SUPPLY

For
**FARM
RADIOS**

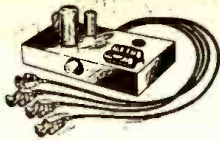

MODEL "Y." Adapts any standard 1½-volt Farm Radio for 6-volt Storage Battery operation. Low drain. No radio changes. Guaranteed. Weight, 4 lbs. Complete (wholesale)—\$6.95.
MODEL "Z." Adapts 4, 5 or 6 tube, 2-volt radios for 6-volt operation. Complete (wholesale)—\$7.95.
BARGAIN BULLETIN—on radio and electrical parts. Prompt shipment. Large stock. Sent on request. Write today.

McGEE RADIO & ELECTRIC CO.
R-1325 McGee Street Kansas City, Mo.

**RADIO
AND
ELECTRONIC
DEVICES**

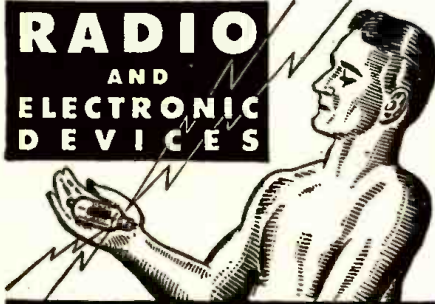

BURSTEIN-APPLEBEE CO.
1012-14 McGee St. Kansas City, Mo.

Headset Headquarters



**GUARANTEE
CANNON-BALL**

Phones to give absolute satisfaction. Unusually sensitive. Noted for fidelity and clarity of tone. Folder C-12 illustrates complete Cannon-Ball line. Write

C. F. CANNON COMPANY
SPRINGWATER, N.Y.

Inventions Wanted
Patented or Unpatented

We have been successfully selling inventions, patented and unpatented, since 1924. Write us, if you have a practical, useful idea for sale.

**CHARTERED INSTITUTE
OF AMERICAN INVENTORS**

Dept. 111, 631 Pa. Ave., N.W., Washington, D.C.

Complete Plans

For Building Useful and Practical Things at Home. Each issue of **Popular Homecraft** is crammed with plans for making such beautiful and useful things as: Furniture, Rice Houses, Lamps, Outdoor Garden Furniture, Candle Equipment, etc. Covers the work of a carpenter, woodworker, leathercraftsman, etc. You'll find "how to make almost everything from the pages of Popular Homecraft. Scores of drawings and photographs make every step simple as A B C. A real "How-To-Do-It" magazine.

Six Months' Trial \$1.00

Send \$1.00 today for trial six months' subscription. Money Back if Not Delighted.

POPULAR HOMECRAFT

837 Palmolive Building Chicago, Ill.

Trial 6 Months \$1.00

PILOT MINE DESTROYERS

(Continued from previous page)

In today's tele-radio-control, the radio impulses are sent out through rotating switches located in both transmitter and receiver. If the enemy does not know the rate of rotation and the exact manner in which impulses are sent out, it becomes almost impossible to interfere.

In the present scheme this is even more true, because radio power and transmission can be such that the effect of the waves will not go much beyond 1000 yards. Moreover, the ultra short wave radio aerials on the pilot tanks can be arranged in such a manner that maximum reception is only from one direction, namely, the control tanks in the rear. Other safeguards, which for security reasons it is not necessary to dwell upon here, will of course be used.

In case faster pilots are needed, ordinary jeeps can be converted into pilots, as is shown graphically on the front cover illustration. In some cases where mines may be buried beneath a depression in the road, and purposely covered with water, a radio-controlled pilot jeep might work out better. That is a matter which the General Staff will have to decide.

What has been said here does not by any means exhaust the possibilities of these radio-controlled pilots. They have a number of other important uses which, however, for reasons of security cannot be told here. It might be asked why use radio control at all? Why not, for instance, connect the pilots with cables to the control tank? The answer is found in the single word—*flexibility*. Thus, for example, in going around sharp bends in the road, the cables might easily foul. Then, there is the weight of the cable that drags behind, and on a rough road it would soon wear unless supported by wheels. This again would make the entire arrangement unwieldy. There is also the matter of having six to ten connecting cables fanning out from the pilots to the rear control tank. Then when one or more pilot tanks run over a mine and are blown up, there will be a general entanglement of cables. That means that the entire pursuing army is automatically stopped in its tracks. That is exactly the one thing that the pursuing army wants least. It wants to get up speed—the more speed the better. Consequently, a radio-controlled pilot tank is ideal for the purpose. If it becomes disabled, it is pushed out of the way and forgotten, or left till a wrecking crew catches up with it and salvages whatever can be saved, for scrap or otherwise.

The radio-controlled pilot, under the present state of the radio art can be made fool-proof in almost every respect. It is cheap, it is safe, it is easy and quick to manufacture—and, most important—it will blow up land mines at no cost to precious lives whatsoever—and that is what counts.

"GIBSON GIRL" WINS AGAIN

THE "Gibson Girl" emergency lifeboat radio described in a recent issue of *Radio-Craft* is credited with the rescue of 19 sick and wounded soldiers from Guadalcanal, when their plane was forced down in the South Pacific, miles from its port.

Continued calls for help were unanswered till the ninth day, when a plane flew overhead and dropped food. Two days later a Navy destroyer arrived and took them off.

The hand-generator apparatus here proved its superiority to battery-types of emergency radio transmitters formerly used. Batteries would have been worn out long before the survivors managed to get a signal through to the rescuers.

PATENTS—TRADE MARKS

Booklet concerning Inventions & Patents Form "Evidence of Conception" with instructions for use and "Schedule of Government and Attorneys Fees"—Free
LANCASTER, ALLWINE & ROMMEL
Registered Patent Attorneys

436 Bowen Bldg. Washington, D. C.

**USED
Correspondence
Courses**

COMPLETE HOME-STUDY COURSES and self-instruction books, slightly used. Sold, rented, exchanged. All subjects. Satisfaction guaranteed. Cash paid for used courses. Full details and 64-page illustrated bargain catalog FREE. Write today!
NELSON COMPANY, 321 S. Wabash, Dept. 210, Chicago

Index to advertisers

Allied Radio Corp.	182
Audel & Company	Back Cover
Amperite	188
Burstein-Applebee	190
Cannon Company, C. F.	190
Chartered Institute of American Inventors	190
Echophone	165
Fada Radio Corp.	189
General Electric Co.	172
Hallicrafters, Inc.	131, 132
Harrison Radio	179
Henry Radio	181
Hudson Specialties	185
Lancaster, Allwine & Rommel	190
McGee Radio Corp.	190
McGraw-Hill Book Co.	183
Meissner Manufacturing Co.	177
National Radio Institute	129
National Schools	175
National Union Radio & Elec.	169
National Union Corp.	186
Nelson Company	190
Ohmite	176
Onan & Sons, D. W.	181
Opportunity Adlets	188
Panoramic Radio Corp.	186
Philco Television Corp.	187
Pioneer Gen-E-Motor	170
Popular Homecraft	190

RADIO SCHOOL DIRECTORY

Page 192

American Schools	
Candler System	
Capitol Radio Engineering Institute	
Commercial Radio Institute	
Lincoln Engineering School	
RCA Institutes	
Tri-State College	

Radcraft Publications, Inc.	189
Radio Corporation of America	
Inside Front Cover	
Radio & Technical Division	163
Sprague Products Co.	167
Sprayberry Academy of Radio	174
Supreme Publications	
Inside Back Cover	
Sylvania Electric Co.	184
Technifax	182, 183
Teleplex	189
Triplet Electrical Instrument Co.	178
Universal Microphone Co.	180
University Laboratories	188
Western Electric Co.	186, 187

(While every precaution is taken to insure accuracy, we cannot guarantee against the possibility of an occasional change or omission in the preparation of this index.)

BOOK REVIEWS

BASIC RADIO PRINCIPLES, by Capt. Maurice Grayle Suffern. Published by McGraw-Hill-Whittlesey House. Stiff cloth covers, $5\frac{1}{2} \times 8\frac{1}{2}$ inches, 271 pages. Price \$3.00.

Designed as a manual to aid in the training of radio repairmen and technicians, all attempts to approach any higher, technical-education level involving mathematics and physics has been avoided. Much of the language is, however, that jargon of the radioman which ignores the fact that all of the terms and most of the words in some explanations of radio action are totally unfamiliar to the student. This puts the book at a disadvantage as a work for home study by persons with no previous radio contacts. It leaves it still a very useful work for the teacher.

The author strikes out independently in the first chapter, starting with transference of energy between circuits and moving immediately to the radio transmitter. The student is thus spared the discouraging experience of wading through several chapters in which radio is not mentioned, as a preliminary to his study of the subject. Interest is maintained by the introduction of radio symbols at the beginning of the next chapter, and by frequent and well-made figures and drawings.

The figures are especially useful in the matter of dealing with vacuum-tube action, and make this occasionally difficult stage of the pupil's progress easy. It is regrettable that the descriptions of electron-tube circuits is not as clear. The student who, without assistance, could understand the item on grid-leak detection would be little short of a genius.

A very useful feature of the book is the quiz section at the end of each chapter. Questions with multiple-choice answers are supplied, to the great benefit of the teacher who may thereby keep a constant check on the students' progress, without waste of time or effort, and without discouraging and tiring him by requiring essays on the subjects studied.

ULTRA-HIGH-FREQUENCY TECHNIQUES, by J. C. Brainerd (Editor), Glenn Koehler, Herbert J. Reich and L. F. Woodruff. Published by the D. Van Nostrand Co. Printed in offset, $6\frac{1}{2} \times 9$ inches, stiff cloth covers, 570 pages. Price \$4.50.

Written co-operatively by four authorities in the field, this text was produced to meet the demand for a book which would cover the course outlined by the representatives of some forty institutions who met at the Massachusetts Institute of Technology late in 1941, to develop a program of defense training in the ultra-high-frequency field.

In spite of the title, the work is fundamental, and covers the principles underlying high-frequency operation as well as the techniques themselves. The aim is to present all material required as a minimum basis for technical work in the high-frequency field. The "level" is said to be that of the senior student in electrical engineering and physics.

The language of the book is simple, and more than one worker whose mathematical attainments are somewhat below the set

level will be able to obtain much useful information from it.

More attention is paid to the cathode-ray tube than in similar texts, a complete chapter being devoted to cathode-ray tubes and circuits. Modulation and de-modulation also receive a chapter each. Otherwise the emphasis is orthodox, with a detailed coverage of wave guides, high-frequency transmission lines and ultra-high-frequency oscillators.

A chapter that will prove interesting to many—not only workers in the ultra-high-frequency field—is the long chapter on trigger circuits, pulse-sharpening circuits and oscillators for producing pulses of various characteristics.

SLIDE RULE SIMPLIFIED, by Charles O. Harris. Published by the American Technical Society. Stiff cloth covers, $6 \times 8\frac{1}{2}$ inches, 250 pages and index. Supplied with a Dietzgen slide rule. Price \$2.50 without rule. With rule \$3.50.

Numerous servicemen and other radio workers, kicked into war jobs which have strained their technical qualifications to the utmost, have discovered that "engineering" is not altogether a mystery. Many things they have been doing in the past by pure intuition can be done quicker and with more assurance of the outcome, by using a certain amount of not-too-difficult mathematics, they find. This factor, coinciding with the appearance of cheap slide-rules on the popular market, has created a tremendous upsurge of interest in that useful and simple instrument.

This text is aimed at that group who have little mathematical knowledge, and seeks first to persuade the would-be user that the slide-rule is a friend and ever-willing assistant, if properly treated. It is pointed out how a person whose mathematics is strictly limited to the eighth-grade level may derive great benefits from its use—can in fact solve problems with its help that he could not possibly do otherwise.

Beginning with the proper way to hold a slide rule, the student is told in simple language, through the first nine chapters, how to perform the fundamental operations and extract square and cube roots. The next four chapters deal with more advanced uses of the rule, based on the trigonometrical scales.

The radioman will regret the neglect of practical radio problems in the various exercises and illustrative examples, which might lead the uninitiated to under-estimate the great value of the slide-rule in radio applications. Otherwise the text is an excellent piece of work, made easier to understand by numerous drawings and more interesting with a number of clever slide-rule cartoons.

HYPER- AND ULTRA-HIGH FREQUENCY ENGINEERING, by Robert I. Sarbacher and William A. Edson. Published by John Wiley & Sons, Inc. Stiff cloth covers; $6 \times 8\frac{1}{2}$ inches, 644 pages. Price \$5.50.

Ultra- and hyper-frequencies, according to the definitions adopted by this book apply to those above 30 megacycles. Orig-

inally no upper limit was implied in the term, but the authors prefer to think of the ultra-high frequencies as those between 30 and 1,000 megacycles, and the hyper-frequencies as those lying between 1,000 and 10,000 megacycles, reserving the term "microwaves" for frequencies still higher in the spectrum.

After covering the theoretical aspects of wave propagation in the first four chapters (the second of which deals with electromagnetic equations and the third with Maxwell's equations), the reader is immediately introduced to the problems of transmission at extremely high frequencies. The text is chiefly concerned with actual propagation, and devotes six chapters to various types of transmission elements, including plane, parallel, rectangular and cylindrical wave guides, as well as chapters on reflection and refraction, and on transmission line theory.

The cavity resonator has a chapter of its own, and radiation from horns and reflectors is given another.

Five chapters are devoted to high frequency tubes, including the special types and the use of grid-type tubes at hyper-frequencies. Both negative and positive grid oscillators are discussed, with an exposition of engineering problems involved in operating the standard negative-grid type of oscillator at very high frequencies. The special high frequency tubes are covered with a chapter on the magnetron, and one covering velocity-modulated tubes. The figures in this section are particularly successful in making clear the action in these tubes. Amplifiers, including high- and low-compensated types for video use, and high-frequency amplifiers, are handled in a single chapter.

The book is especially noteworthy because of the detail in which the actual production of oscillations at high-frequency is handled. Several figures and illustrations given in this connection are remarkably clear.

MATHEMATICS ESSENTIAL TO ELECTRICITY AND RADIO, by Nelson M. Cooke and Dr. Joseph B. Orleans. Published by McGraw-Hill Book Co. Stiff cloth covers, 6×9 inches, 418 pages. Price \$3.00.

This book is an adaptation of Lieutenant Cooke's "Mathematics for Electricians and Radiomen" to the secondary-school level and teaching techniques. A more compact work, it is adapted to courses where the ground must be covered rapidly.

The main advantages of the original work are retained. Subjects are arranged along an electrical rather than a mathematical sequence, without sacrifice of mathematical continuity. As a matter of fact, the book is excellent if judged solely from the mathematical point of view.

The book can be used by anyone who understands ordinary arithmetic. It begins with literal numbers, and carries on to the necessary quadratics, logarithmic methods, trigonometry and vectorial computations for radio work.

Clearly and well written, this should be a good book for the independent student as well as the one who has an opportunity to attend a mathematics class.

TELEVISION FINDS MISSING LINES

Television is now being used to assist in the search for missing persons, according to a statement made last month by the New York Police Department. The service, which started October 3rd, projects the pictures of missing individuals on the screens of television receivers in

New York's 85 scattered station houses. The television receivers have been installed for some time, but hitherto their use was confined to activities in connection with civilian defense. The broadcasts are being handled by W2XWV, station of the DuMont Television Laboratories.

Radio School Directory

TO OUR READERS—NOW IS THE TIME TO TAKE UP RADIO!

NOW, more than ever before America needs trained radio men. The Army, the Navy and the Air Force are continuously on the lookout for men who have had training in radio. Scores of war industries require radio men in various capacities throughout the country. There now is and there will be a great shortage of radio men for years to come. Reputable schools of Radio advertise to help you.

RADIO TECHNOLOGY



BCA Institute offers an intensive two-year course of high standard embracing all phases of Radio and Television. Practical training with modern equipment. Also shorter specialized courses in Commercial Radio Operating, Radio and Television Servicing, and Aviation Communications. For Free Catalog write Dept. RC-48.

RCA INSTITUTES, Inc.

A Radio Corporation of America Service
75 VARICK STREET NEW YORK 13, N. Y.



Correspondence Courses in
RADIO and ELECTRICAL ENGINEERING

ELECTRICAL ENGINEERING Get good grasp electrical field. Prepare yourself, at Low Cost, for secure future. Modern, simplified, you can understand quickly.
RADIO ENGINEERING Extra fine course in radio, public address, photo-electric work. Trains you to be super-service man, real vacuum tube technician. Servicemen needed badly. Diploma on completion. Tuition \$25, either course. Deferred payment plan. **FREE** Get copies of school catalogs, student magazines, complete details. SEND NOW!
LINCOLN ENGINEERING SCHOOL Franklin Stn., Box 61, C58 WASHINGTON, D. C. (Formerly at Lincoln, Nebr.)

RADIO ENGINEERING I

DEGREE IN 27 MONTHS

RADIO Engineering offers unusual opportunities for WOMEN as well as MEN. B. S. Degree. Modern laboratory, latest equipment. Courses also in Civil, Electrical, Mechanical, Chemical, Aeronautical Engineering; Business Administration, Accounting, Secretarial Science, Special Preparatory Dept. Tuition, living costs low. Enter Jan., March, June, Sept. **Catalog.**
TRI-STATE COLLEGE 2412-3 College Ave. ANGOLA, INDIANA

COMMERCIAL RADIO INSTITUTE

A radio training center for twenty-three years.

RESIDENT COURSES ONLY

Pre-Induction, Broadcast, Service, Aeronautical and Radio telegraphy classes now forming for February 7. Literature upon request.
Dept. C., 38 West Biddle St., Baltimore 1, Md.



RADIO OPERATORS WANTED

Learn to Send and Receive Radio Code at home or in Camp, or prepare for higher proficiency and rating through same easy, practical System used in training radiotelegraph specialists. Thousands of operators needed. Write for FREE book.

CANDLER SYSTEM CO.

Dept. 3-0, Box 928, Denver 1, Colo., U.S.A.

RADIO OPERATION SERVICING COMPLETE HOME TRAINING

Fit yourself for important work in wartime, and after. Make use of your spare time to master basic principles of radio. Up-to-date course includes electives in operating and servicing. Write for FREE FULL-TEXT. No obligation.
AMERICAN SCHOOL
Dept. 899, Drexel at 58th St., Chicago 37, Ill.

WILL YOU BE READY...



For A Secure Job In The Coming New World of Electronics?

Join the ambitious radiomen who are assuring themselves of secure good-paying jobs with a planned program of CREI technical training in Practical Radio-Electronics Engineering.

You can study at home in your spare time—develop your technical ability—increase your knowledge to keep pace with important developments now taking place in the industry.

When the war is over, the good jobs will go to the "survival of the fittest," so make sure that you will not be left behind. Get ready now for a secure job in the coming new world of Electronics.

● WRITE FOR FREE 32-PAGE BOOKLET

If you have had professional or amateur radio experience and want to make more money—let us prove to you we have something you need to qualify for a better radio job. To help us intelligently answer your inquiry—PLEASE STATE BRIEFLY YOUR BACKGROUND OF EXPERIENCE, EDUCATION AND PRESENT POSITION.



CAPITOL RADIO ENGINEERING INSTITUTE

Home Study Courses in Practical Radio-Electronics
Engineering for Professional Self-Improvement
Dept. RC-12, 3224-16th St., N. W.
WASHINGTON 10, D. C.

Contractors to the U. S. Navy, U. S. Coast Guard and Canadian Broadcasting Co.
Producers of Well-trained Technical Radiomen for Industry.

LISTENING POST

(Continued from page 174)

Mc.	Call	Location and Schedule
17.48	—	ALASKA; Saturdays, 6:45 pm; irregular.
17.765	—	VICHY, FRANCE; not heard recently.
17.72	LRA5	BUENOS AIRES, ARGENTINA; Fridays, 5 to 5:30 pm.
17.750	WRUW	BOSTON, MASSACHUSETTS; North African beam, 10:15 to 11:45 am; European beam, noon to 2:15 pm.
17.760	KROJ	LOS ANGELES, CALIFORNIA; 9 to 10 pm.
17.760	WKRD	NEW YORK CITY; South African beam, 9:15 to 11:15 am; Central Africa beam, 11:30 am to 12:30 pm.
47.775	OPL	LEOPOLDVILLE, BELGIAN CONGO; unheard recently.
17.780	WRCA	NEW YORK CITY; European beam, 9 am to 2:45 pm.
17.780	WNBI	NEW YORK CITY; South America beam, 5:30 to 6:45 pm; Sundays 5:30 to 7:30 pm.
17.800	WLWO	CINCINNATI, OHIO; European beam, 9:15 am to 3:30 pm; West South America beam, 5:30 to 6:45 pm.
17.800	TGWA	GUATEMALA CITY, GUATEMALA.
17.830	WCDA	NEW YORK CITY; European beam; 7:45 am to 4:45 pm.
18.135	YDA	BATAVIA, JAVA; India beam, ? to noon.
20.040	OPL	LEOPOLDVILLE, BELGIAN CONGO.

STATEMENT OF THE OWNERSHIP, MANAGEMENT, CIRCULATION, ETC., REQUIRED BY THE ACT OF CONGRESS OF AUGUST 24, 1912, AND MARCH 3, 1933.

Of Radio-Craft and Popular Electronics, published monthly at Springfield, Mass., for October 1, 1943.

County of New York } ss.
State of New York

Before me, a Notary Public in and for the State and county aforesaid, personally appeared HUGO GERNSBACK, who having been duly sworn according to law, deposes and says that he is the editor of Radio-Craft and Popular Electronics, and that the following is, to the best of his knowledge and belief, a true statement of the ownership, management (and if a daily paper, the circulation), etc., of the aforesaid publication for the date shown in the above caption, required by the Act of August 24, 1912, as amended by the Act of March 3, 1933, embodied in section 537, Postal Laws and Regulations, printed on the reverse of this form, to wit:

1. That the names and addresses of the publisher, editor, managing editor, and business managers are: Publisher, Radcraft Publications, Inc., 25 West Broadway, New York, N. Y.; Editor, H. Gernsback, 25 West Broadway, New York, N. Y.; Managing Editor, none; Business Managers, none.

2. That the owner is: (If owned by a corporation, its name and address must be stated and also immediately thereunder the names and addresses of stockholders owning or holding one per cent or more of total amount of stock. If not owned by corporation, the names and addresses of the individual owners must be given. If owned by a firm, company, or other unincorporated concern, its name and address, as well as those of each individual member must be given.) Radcraft Publications, Inc., 25 West Broadway, New York, N. Y.; H. Gernsback, 25 West Broadway, New York, N. Y.

3. That the known bondholders, mortgagees, and other security holders owning or holding 1 per cent or more of total amount of bonds, mortgages, or other securities are: (If there are none, so state.) None.

4. That the two paragraphs next above, giving the names of the owners, stockholders, and security holders, if any, contain not only the list of stockholders and security holders as they appear upon the books of the company but also, in cases where the stockholder or security holder appears upon the books of the company as trustee or in any other fiduciary relation, the name of the person or corporation for whom such trustee is acting, is given; also that the said two paragraphs contain statements embracing affiant's full knowledge and belief as to the circumstances and conditions under which stockholders and security holders who do not appear upon the books of the company as trustees, hold stock and securities in a capacity other than that of a bona fide owner; and this affiant has no reason to believe that any other person, association, or corporation has any interest, direct or indirect, in the said stock, bonds, or other securities than as so stated by him.

5. That the average number of copies of each issue of this publication sold or distributed through the mails or otherwise, to paid subscribers during the twelve months preceding the date shown above is (This information is required from daily publications only.)

(Signature of publisher)

H. GERNSBACK.

Sworn to and subscribed before me this 28th day of September, 1943.

MAURICE COYNE, Notary Public
(Commission expires March 30, 1944)

[Seal]

**MOST
OFTEN
NEEDED**

RADIO DIAGRAMS



1942

**4 out of 5
Diagrams You Need**

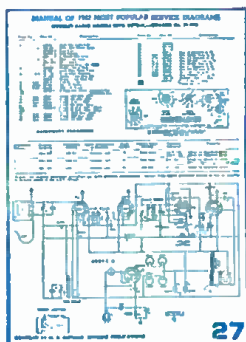

Find radio faults quickly. Make the needed repairs in any radio. Save time on every job. This large, inexpensive diagram manual has the circuit for every popular 1942 radio set. 4 out of 5 diagrams you will ever need are included.

ALIGNMENT DATA INCLUDED

Clearly printed circuits, alignment data, parts lists, service hints are the facts you need to speed up War-time servicing. Repair radios quickly and properly - follow the factory instructions given in these manuals. 351 models of 40 largest manufacturers. 208 fact packed pages. Large size, 8 1/2 x 11 in. Manual style binding. Price, postpaid **\$2.00**

POPULAR, LOW-PRICED MANUALS

1941

These easy-to-apply, inexpensive manuals will help you repair radios faster. This volume covers 1941 models, with alignment data, I.F. peaks, and replacement parts lists. Compiled by M. N. Beitman, radio serviceman for many years, author, and teacher. Be an expert in radio servicing; simplify your work. 192 pages, 8 1/2 x 11 inches. Only **\$2.00**

1940

Let this important manual give you over 80% of all 1940 circuits you will ever need, acquaint you with new developments, train you to service quickly and efficiently millions of sets. Data on P.M., portables, recorders, etc. 417 models of 43 manufacturers. 208 pages. Net price **\$2.00**



1939

Another handy manual of most-popular diagrams you need. Circuit data, hints, and information are time-savers and money-makers for you. Let these diagram manuals guide you to easier service work. Why try to get along without helpful diagrams? Use this volume with 192 pages of diagrams of 39 makes. Only **\$2.00**

Most Popular Models Made by:

Philco, RCA, Zenith, Sears, GE, Emerson, Belmont, Detrola Radio, Fada, United Motors, Westinghouse, Arvin, Majestic, Stewart-Warner, Admiral, Delco, Stromberg-Carlson, Western Auto, Spartan, Wards, Motorola, Gamble, and many others.

Other Practical Radio Manuals

How to MODERNIZE Radios for Profit



Cash-in by improving audio circuits, modernizing cabinets, adding features usually found on late model sets. Practical job-sheets with schematics and photographs make the work easy. You are told how to obtain modernization work, what to charge, and how to complete the job quickly and efficiently. The complete, large size, 8 1/2 x 11 in. manual is priced at only **\$1.00**

PRACTICAL RADIO FOR WAR TRAINING

This new, 1943 manual will clarify the important radio facts, explain the principles which may have puzzled you, and point the way to faster radio repairing. You will find hundreds of practical hints for mounting parts, testing components, trouble-shooting, using instruments. Needed useful theory in each chapter is followed with practical applications. This is the book that will help you repair radios faster, or obtain a good radio War-job, or get ahead in the Armed Forces. Use this timely book as your ready reference for finding the right answer to every radio problem. Written by M. N. Beitman, 336 large pages, 6x9 inches. Printed on thick, enamel paper. Almost 300 illustrations and diagrams to help you. Seal leatherette cover. Attractive manual-binding. Price only **\$2.95**

PRACTICAL RADIO MATHEMATICS

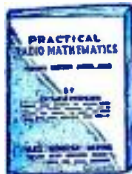

Introduces and explains the use of arithmetic and elementary algebra in connection with units, color code, meter scales, Ohm's Law, alternating currents, ohmmeter testing, wattage rating, series and parallel connections, capacity, inductance, mixed circuits, vacuum tubes, curves, the decibel, etc., etc., and has numerous examples. Net **25c**

See Your Radio Jobber or Send Coupon

1926-1938

The most popular volume of the series. Will pay for itself with the time saved during the first day of use. Includes all the popular old timers. Save hours on every job. 427 diagrams of the most-serviced radios of this period, with parts lists and alignment information. 244 pages, 8 1/2 x 11 inches. Sold with a money back guarantee. Price, postpaid **\$2.50**



Compiled by M. N. Beitman, radio engineer, teacher, author, & serviceman.

SAVE HOURS ON EVERY JOB

Be ready to make repairs in minutes instead of hours. You will be called upon to fix hundreds of models listed in these easy-to-use manuals. Tackle each job with the needed help found in these service manuals. Greatest bargain in diagram books. Send your order today. Use these manuals this week.

NO RISK TRIAL ORDER COUPON

SUPREME PUBLICATIONS, 328 S. Jefferson St., Chicago 6, ILL.

Ship the following manuals: (Money back guaranteed).

- 1942 1941 1940 1939 1926-1938

Also send other Supreme Publications as listed on attached paper.

I am enclosing \$....., send postpaid. Send C.O.D.

Name:

Address:

(Use Coupon or Send Order in a Letter)

Supreme Publications

PUBLISHERS OF RADIO BOOKS, MANUALS, AND DIAGRAMS

328 South Jefferson Street

Chicago, Illinois

Audels RADIOMANS GUIDE

1001 RADIO FACTS AND FIGURES

772 PAGES · 400 DIAGRAMS, CHARTS AND PHOTOS

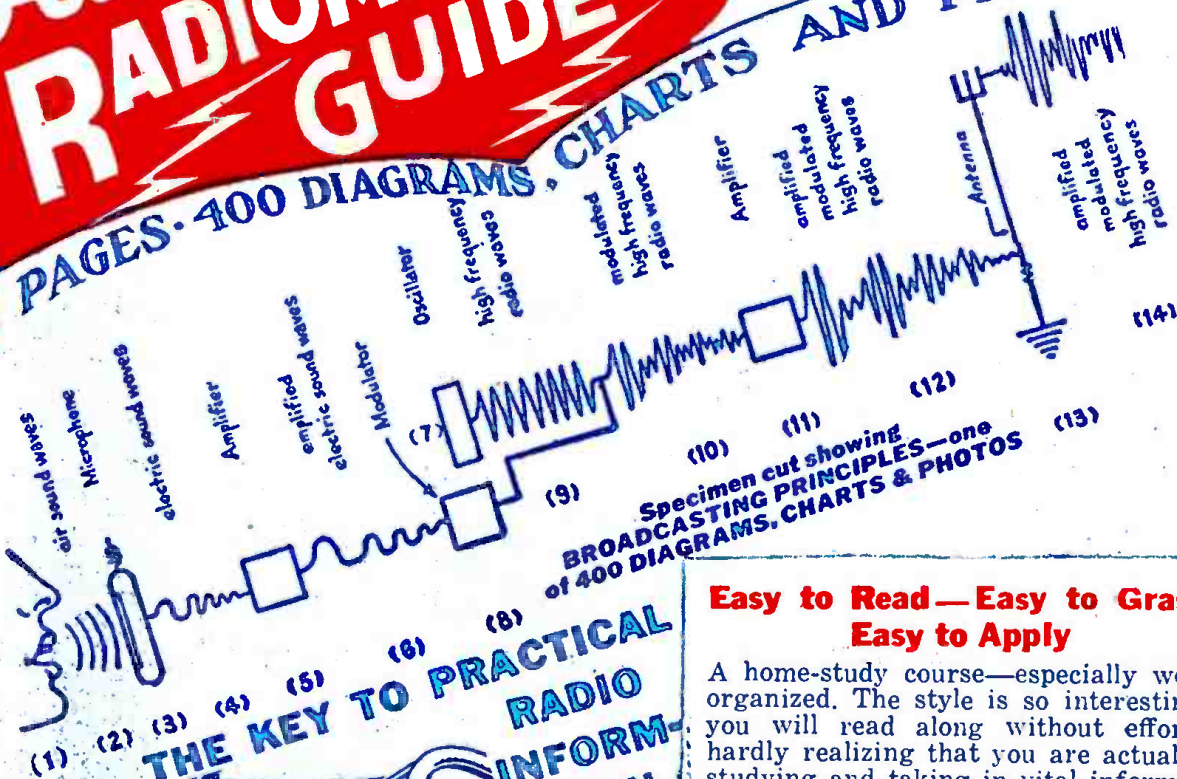

THE KEY TO PRACTICAL RADIO INFORMATION

It gives you in usable form pointers on radio, including frequency modulation, television, etc. Also valuable inside information for Aviators, Marines, Commercial Operators and Technicians, Servicemen and Students.



**Q AND A
UNIQUE
QUESTION
and
ANSWER
METHOD**

**Easy to Read—Easy to Grasp
Easy to Apply**

A home-study course—especially well organized. The style is so interesting you will read along without effort, hardly realizing that you are actually studying and taking in vital information. Audels Radiomans Guide gives you just the right amount of mathematics required to cope with radio problems successfully. You can solve, with the aid of this extraordinary book, practically every radioproblem that comes up. At your finger tips is a complete index for instant use.



Highly Endorsed

A COMPLETE LIBRARY IN ONE BOOK

AUDELS RADIOMANS GUIDE gives authentic Principles and Practices in Construction, Operation, Service and Repairs. Covers clearly and concisely radio fundamentals—Ohm's Law—Physics of sound as related to radio science—Measuring instruments—Power supply—Resistors—Inductors—Condensers—Transformers and examples—Broadcasting stations—Radio Telephony—Receivers—Diagrams—Construction—Control Systems—Loudspeakers—Antennas—AutoRadio—Phonograph Pick-ups—Public Address Systems—Aircraft and Marine Radio—Radio Compass—Beacons—Automatic Radio Alarms—Short Wave—Coil Calculations—Testing—Cathode Ray Oscillographs—Static Eliminations—Trouble Pointers—Underwriter's standards—Units and tables. REVIEW QUESTIONS—READY Reference Index.

\$ 4 COMPLETE PAY \$1 ONLY 7 DAYS' FREE TRIAL

THEO. AUDEL & CO., Publishers
49 West 23rd Street, 10, New York

Mail AUDELS NEW RADIOMAN'S GUIDE for free examination. If O.K. I will send you \$1 in 7 days; then remit \$1 monthly until \$4 is paid. Otherwise I will return it.

Name _____
Address _____
Occupation _____
Reference _____

MAIL THIS COUPON TODAY

RCF

ADV Plans, LLC

Copyright Notice:

The entire contents of this CD/DVD are copyright 2014 by ADV Plans, LLC. All Rights Reserved.

Reproduction or distribution of this disk, either free or for a fee is strictly prohibited. We actively monitor and remove listings on eBay thru Vero.

You are free to copy or use individual images in your own projects, magazines, brochures or other school projects.

Only the sellers listed here are authorized distributors of this collection:
www.theclassicarchives.com/authorizedsuppliers

Please view our other products at
www.theclassicarchives.com,
or our ebay stores:

[TheClassicArchives](#)
[ADVPlans](#)
[SuperShedPlans](#)

